



John Thomas
The Mad Hedge Fund Trader

How to guarantee a comfortable retirement. Pick the right industries, and you can cash in on the coming 20-fold rise in stocks during the 2020s and 2030s.

**STOCKS TO BUY
FOR THE COMING**

**ROARING
TWENTIES**



Edition Three





Introduction to
Stocks to Buy for the Coming Roaring Twenties
by John Thomas

Far and away the greatest impact on the performance of any balanced investment portfolio is single stock selection.

Get a few ten baggers in there and your overall annual profits instantly jump from mediocre to eye-popping.

For that reason, the ***Diary of a Mad Hedge Fund Trader*** devotes a disproportionate share of its resources to uncovering these gems.

It accomplishes this through investing in the deep long-term research essential to identifying the handful of industries and companies that will lead the global economy forward for decades to come.

Stocks to Buy for the Coming Roaring Twenties represents the cream of 10 years of such research efforts.

So far, our track record in discovering ten baggers has been pretty good.

In 2009, we recommended Baidu, the Chinese Internet search giant, which went on to dominate the business in the Middle Kingdom. It took repeated visits to the company in China for me to flesh out its long-term prospects. Its shares rocketed 20-fold from \$12 to \$240.

In 2010, we piled our followers in Tesla foreseeing a revolution in automobile technology, manufacturing, and marketing. The battery is almost an afterthought.

That conclusion was reached through a personal relationship with founder Elon Musk, and multiple visits to the Fremont, California factory.

I have been test-driving Tesla's Model S-1 for the past four years, clocking some 50,000 miles and one crash. The shares soared 18 times, from \$16 to \$292.

That year I also introduced readers to Cheniere Energy (LNG), a firm I knew well from my long experience in the energy industry.

Quite simply, Cheniere is in the business of buying natural gas for \$2 a BTU and selling it in Asia for \$16. It is the only firm with the technology, licenses, permits, and plant to do so. The shares went ballistic, leaping 14 fold from \$6 to \$85.

I could go on and on.

The bottom line is that this is what I love doing. Having a half-century of experience ferreting out these nuggets also helps a lot.

It also doesn't hurt that I am based on the edge of Silicon Valley where amazing investment opportunities are being born on a daily basis.

To receive daily updates on these and other long-term investment themes across all asset classes, please visit my website at www.madhedgefundtrader.com, and subscribe to my research and trade mentoring service.

Regards,
John Thomas
Publisher and CEO
The Diary of a Mad Hedge Fund Trader

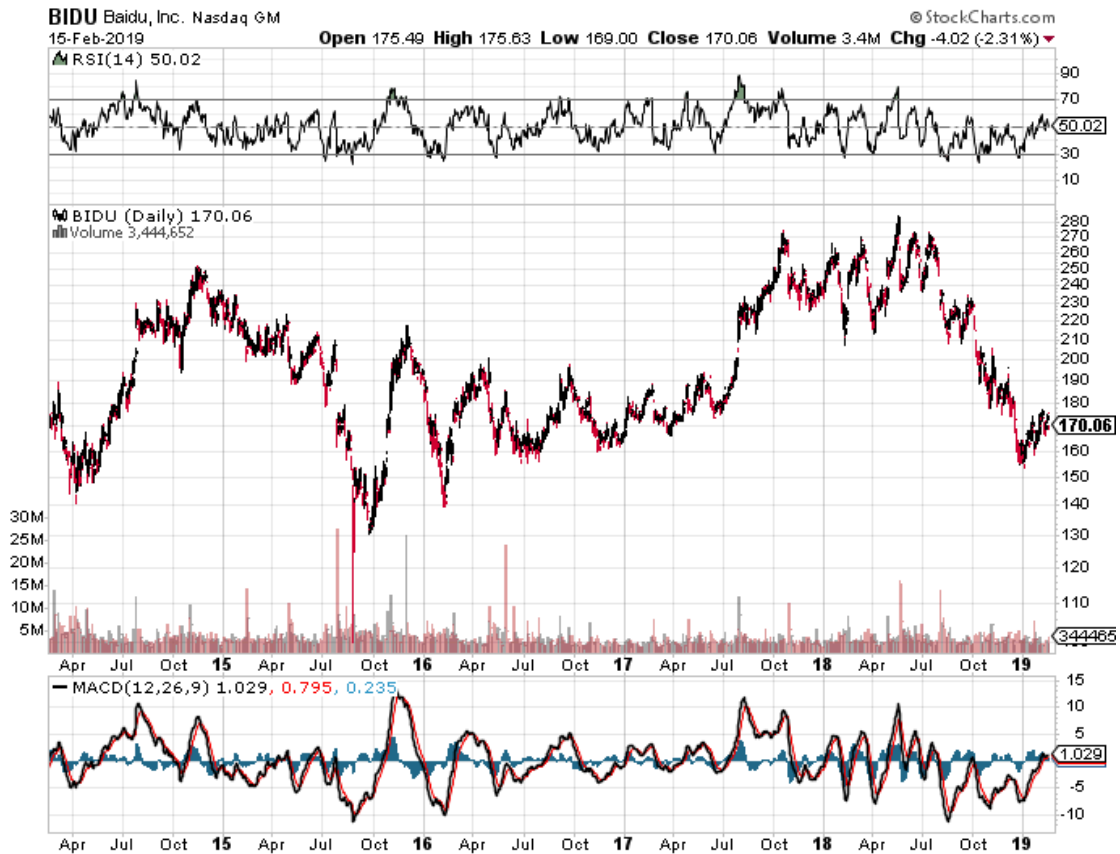

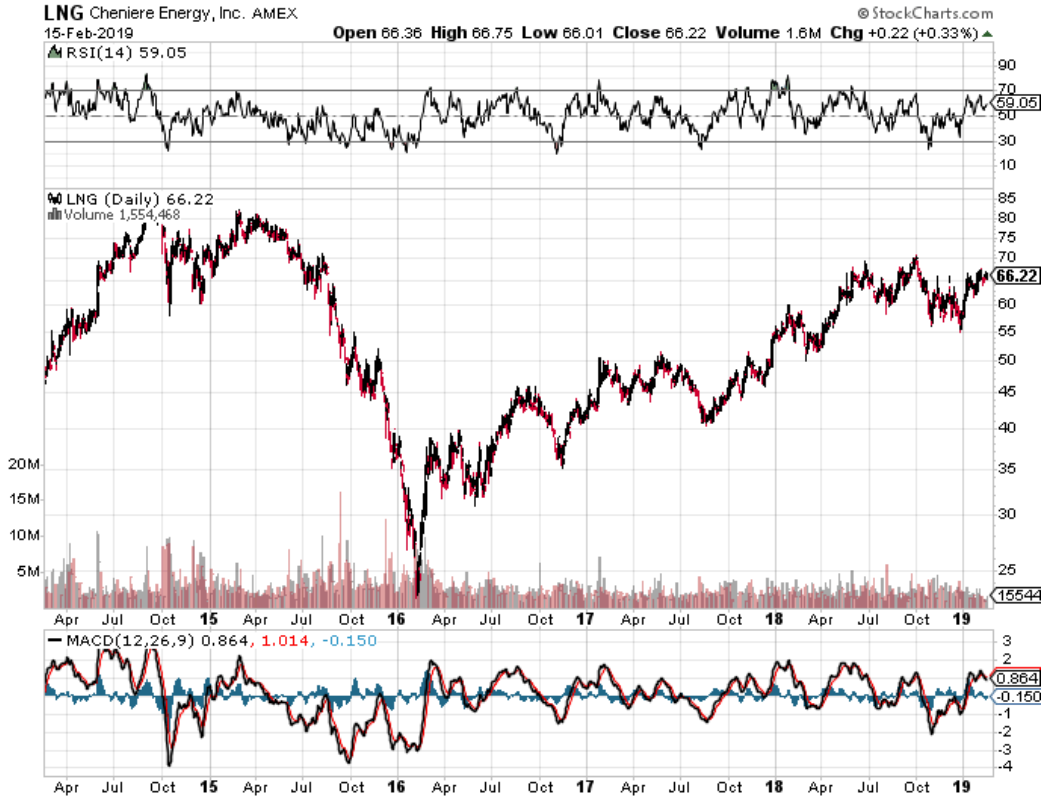

Biography of John Thomas - The Mad Hedge Fund Trader

John Thomas graduated from the University of California at Los Angeles (UCLA) with a degree in Biochemistry and a minor in Mathematics in 1974.

He moved to Tokyo, Japan to join a Japanese securities house as a research analyst, becoming fluent in Japanese.

In 1976, he was appointed the Tokyo correspondent for *The Economist* magazine and the *Financial Times*.

For the next seven years, he published thousands of articles about the economies, companies, and leaders of every country in Asia. He was one of the first American correspondents to cover China during the Cultural Revolution.

He reported on the American attempt to climb Mount Everest and guerilla wars throughout Southeast Asia.

The major figures he interviewed included China's Premier Deng Xiaoping, Ferdinand Marcos of the Philippines, the UK's Margaret Thatcher, the PLO's Yasser Arafat, CIA head William Colby, and of course, President Ronald Reagan.

In 1982, John Thomas moved to New York as the U.S. editor of a major business magazine. As a member of the White House press corps, he covered the early years of the Reagan administration.

A year later in 1983, he was hired by a major investment bank to build a new division in international equities. Later, he was promoted and transferred to London to head up the sales and trading of Japanese equity derivatives in Europe and the Middle East.

Then in 1989, John Thomas was appointed a director of the Swiss Bank Corp responsible for its then vast portfolio of Japanese equity derivatives.

A year later, he left to set up the first-ever dedicated international hedge fund which became a top performer in the industry.

In 1999, John Thomas sold his hedge fund to concentrate on managing his personal investments. He focused on natural gas exploration and development in Texas and Colorado as well as other commodities.

This made him one of the early pioneers in the “fracking” technology which is now dramatically reshaping America’s energy landscape. After catching a double in the price of natural gas, John sold this business in 2005.

Seeing the incredible inefficiencies and severe mispricing offered by the popping of multiple bubbles during the Great Crash of 2008, and missing the adrenaline of the marketplace, he returned to active hedge fund management.

With *The Diary of a Mad Hedge Fund Trader*, his goal is to broaden public understanding of the techniques and strategies employed by the most successful hedge funds so that they may more profitably manage their own money.

In his free time, John Thomas climbs mountains, does long distance backpacks, practices karate, performs aerobatics in antique aircraft, collects vintage wines, reads the Japanese classics, and engages in a wide variety of public service and philanthropic activities.

His career has taken him up to 20,000 feet on Mount Everest, to the edge of space at 90,000 feet in the cockpit of a MiG-25, and to the depths of a sunken Japanese fleet in the Chuuk Lagoon (formerly known as Truk Lagoon).

Why they call him "mad" he will never understand.

Table Of Contents

<u>SECTION</u>	<u>PAGE</u>
Get Ready for the Next Golden Age	7
Making a Fortune in Real Estate - Part I	11
Making a Fortune in Real Estate - Part II	15
Making a Fortune in Real Estate - Part III	19
The Second Industrial Revolution	26
The Quantum Computer in Your Future	31
The Great Artificial Intelligence Stock Play You've Never Heard of	36
Why Energy Prices are About to Collapse	46
Revolutionary New Discovery Converts CO2 into Alcohol	54
Industries You Will Never Hear From Me About	59
Why Globalization Works	61
Will SpaceX Be Your Next Ten Bagger?	66
Will Airbnb Be Your Next Ten Bagger?	75
Why Water is One of 2019's Best Sectors	81
Biotech and Healthcare Stocks to Buy at the Bottom	86
The Ultra Bull Argument for Gold	91
Diamonds Are Still an Investor's Best Friend	99
The Ten Baggers in Cybersecurity	101
Welcome to the Deflationary Century	107
Death of the Car	111
Print Your Own Car	116
How Tesla Takes Over the World - Part I	119
How Tesla Takes Over the World - Part II	125
How Tesla Takes Over the World - Part III	128
The Battery in Your Future	132
The American Onshoring Trend is Accelerating	135
Do You Want to Live Forever?	138
Peeking Into the Far Future With Ray Kurzweil	146

Get Ready for the Next Golden Age

I believe that the global economy is setting up for a new golden age reminiscent of the one the United States enjoyed during the 1950s and which I still fondly remember.

This is not some pie-in-the-sky prediction. It simply assumes a continuation of existing trends in demographics, technology, politics, and economics. The implications for your investment portfolio will be huge.

What I call “intergenerational arbitrage” will be the principal impetus. The main reason that we are now enduring two “lost decades” of economic growth is that 80 million baby boomers are retiring to be followed by only 65 million “Gen Xers.”

When the majority of the population is in retirement mode, it means that there are fewer buyers of real estate, home appliances, and “RISK ON” assets such as equities, and more buyers of assisted living facilities, healthcare, and “RISK OFF” assets such as bonds.

The net result of this is slower economic growth, higher budget deficits, a weak currency, and registered investment advisors who have distilled their practices down to only municipal bond sales.

Fast-forward to six years when the reverse happens and the baby boomers are out of the economy, worried about whether their diapers get changed on time or if their favorite flavor of Ensure is in stock at the nursing home. That is when you have 65 million Gen Xers being chased by 85 million of the “millennial” generation trying to buy their assets.

By then, we will not have built new homes in appreciable numbers for 20 years and a severe scarcity of housing hits. Residential real estate prices will soar. Labor shortages will force wage hikes. The middle-class standard of living will reverse a then 40-year decline. Annual GDP growth will return from the current subdued 2% rate to near the torrid 4% seen during the 1990s.

The stock market rockets in this scenario. Share prices may rise very gradually for the rest of the teens as long as tepid 2% growth persists. A 5% annual gain takes the Dow to 20,000 by 2020. After that, we could see the same fourfold return we saw during the Clinton administration taking the Dow to 100,000 by 2030. If I’m wrong, it will hit 200,000 instead. Emerging stock markets (EEM) with much higher growth rates do far better.

This is not just a demographic story. The next 20 years should bring a fundamental restructuring of our energy infrastructure as well. The 100-year supply of natural gas (UNG) we recently have discovered through the new “fracking” technology will finally make it to end users replacing coal (KOL) and oil (USO). Fracking applied to oil fields is also unlocking vast new supplies.

Since 1995, the United States Geological Survey estimate of recoverable reserves has ballooned from 150 million barrels to 8 billion. OPEC's share of global reserves is collapsing. This is all happening while automobile efficiencies are rapidly improving and the use of public transportation soars.

Mileage for the average U.S. car has jumped from 23 to 24.7 miles per gallon in the past couple of years and the administration is targeting 50 mpg by 2025. Total gasoline consumption is now at a five-year low.

OPEC share of world crude oil reserves, 2017

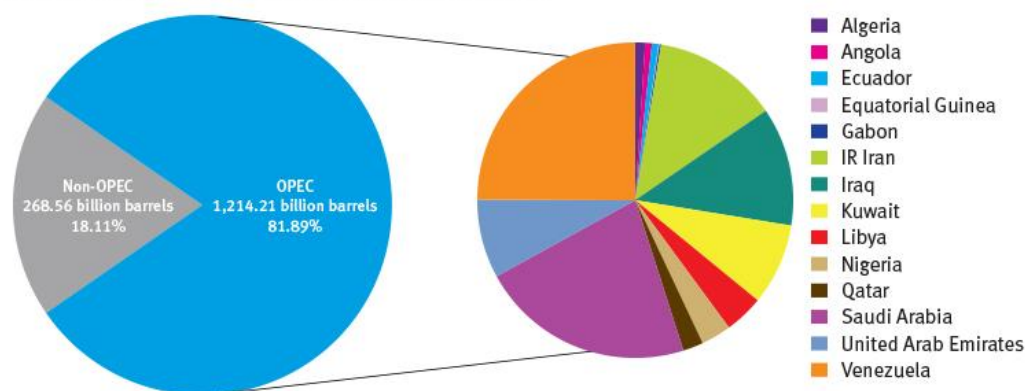

OPEC proven crude oil reserves , at end 2017 (billion barrels, OPEC share)

Venezuela	302,81	24,9%	Kuwait	101,50	8,4%	Qatar	25,24	2,1%	Gabon	2,00	0,2%
Saudi Arabia	266,26	21,9%	UAE	97,80	8,1%	Algeria	12,20	1,0%	Equat. Guinea	1,10	0,1%
IR Iran	155,60	12,8%	Libya	48,36	4,0%	Angola	8,38	0,7%			
Iraq	147,22	12,1%	Nigeria	37,45	3,1%	Ecuador	8,27	0,7%			

Source: OPEC Annual Statistical Bulletin 2018.

Alternative energy technologies will also contribute in an important way in states such as California, accounting for 30% of total electric power generation by 2020. I now have an all-electric garage with a Nissan Leaf (NSANY) for local errands and a Tesla Model S-1 (TSLA) for longer trips allowing me to disappear from the gasoline market completely. Millions will follow. The net result of all of this is lower energy prices for everyone.

It will also flip the U.S. from a net importer to an exporter of energy with hugely positive implications for America's balance of payments. Eliminating our largest import and adding an important export is very dollar bullish for the long term. That sets up a multiyear short for the world's big energy-consuming currencies, especially the Japanese yen (FXJ) and the Euro (FXE). A strong greenback further reinforces the bull case for stocks.

Accelerating technology will bring another continuing positive. Of course, it's great to have new toys to play with on the weekends, send out Facebook photos to the family, and edit your own home videos. But at the enterprise level, this is enabling speedy improvements in productivity that are filtering down to every business in the U.S. lowering costs everywhere.

This is why corporate earnings have been outperforming the economy as a whole by a large margin. Profit margins are at an all-time high. Living near booming Silicon Valley, I can tell you that there are thousands of new technologies and business models that you have never heard of under development. When the winners emerge, they will have a big cross-leveraged effect on the economy.

New healthcare breakthroughs will make serious diseases a thing of the past which are also being spearheaded in the San Francisco Bay Area. This is because the Golden State thumbed its nose at the federal government 10 years ago when the stem cell research ban was implemented. It raised \$3 billion through a bond issue to fund its own research even though it couldn't afford it.

I tell my kids they will never be afflicted by my maladies. When they get cancer in 20 years, they will just go down to Walmart and buy a bottle of cancer pills for \$5, and it will be gone by Friday. What is this worth to the global economy? Oh, about \$2 trillion a year, or 4% of GDP. Who is overwhelmingly in the driver's seat on these innovations? The USA.

There is a political element to the new Golden Age as well. Gridlock in Washington can't last forever. Eventually, one side or another will prevail with a clear majority.

This will allow the government to push through needed long-term structural reforms, the solution of which everyone agrees on now but for which nobody wants to be blamed. That means raising the retirement age from 66 to 70 where it belongs, and means-testing recipients. Billionaires don't need the maximum \$30,156 annual supplement. Nor do I.

The ending of our foreign wars and the elimination of extravagant, unneeded weapons systems cut defense spending from \$800 billion a year to \$400 billion, or back to the 2000, pre-9/11 level. Guess what happens when we cut defense spending? So does everyone else.

I can tell you from personal experience that staying friendly with someone is far cheaper than blowing them up. A ***Pax Americana*** would ensue. That means China will have to defend its own oil supply instead of relying on us to do it for them. That's why they have recently bought a second used aircraft carrier. The Middle East is now their headache.

Sure, this is all very long-term, over-the-horizon stuff. You can expect the financial markets to start discounting a few years hence, even though the main drivers won't kick in for another decade. But some individual industries and companies will start to discount this rosy scenario now.

Perhaps this is what the nonstop rally in stocks since 2009 has been trying to tell us.



Dow Average 1900-2015



Another American Golden Age is Coming

Click [HERE](#) to Learn more about Mad Hedge Fund Trader and the services we offer.

Making a Fortune in Real Estate - Part I

If you weren't born yet in 2008 or were living in a cave on a remote Pacific island back then, go watch the movie "**The Big Short**" for a further explanation of those dark days.

As a result, real estate closings now take at least a week longer, and sometimes more, thanks to a new requirement for several three-day "cooling off periods."

When the new law kicked in, TRID nearly brought the industry to a halt and firms were sent scurrying to their attorneys to draw up the new disclosure forms to stay within the law.

TRID undoubtedly was responsible for the slowdown in the market in the run-up to December. Although prices seem high now, I am convinced that we are only at the beginning of a long-term secular bull market in housing. Anything you purchase now is going to make you look like a genius 10 years down the road.

The best is yet to come.

The big driver will be demographics, of course.

From 2022 onward, 65 million Gen Xers will be joined by 85 million late blooming Millennials in bidding wars for the same houses. That will create a market of 150 million buyers, unprecedented in the history of the American real estate market.

In the meantime, 80 million baby boomers, net sellers and downsizers of homes for the past decade, will slowly die off and disappear from the scene as a negative influence. Only one-third are still working.

The first boomer, Kathleen Casey-Kirschling, born seconds after midnight on January 1, 1946, will become 76 years old by 2022. A former school teacher, she took early retirement at 62.

The real fat on the fire here is that 5 million homes went missing in action this decade, thanks to the financial crisis. They were never built.

This is the result of the bankruptcy of several home builders, and the newfound ultra conservatism of the survivors, like D.R. Horton (DHI), Lennar Homes (LEN), and Pulte Group (PHM).

Did I mention that all of this makes this sector a screaming "BUY" once the market moves into "RISK ON" mode later in the year?

Talk to any real estate agent and he will complain about the shortage of inventory (except in Chicago, the slowest growing market in the country).

Prices are so high already that flippers have been squeezed out of the market for good. Bottom feeders, like hedge funds buying at the bankruptcy auctions, are a distant memory. Some now own more than 20,000 homes.

Income taxes are certain to rise in coming years, and the generous deductions allowed homeowners are looking more attractive by the day.

And let's face it, ultra-low interest rates aren't going to be here forever. Borrow at 3% today against a long-term 3% inflation rate, and you are essentially getting your house for free.

The rising rents that are turning Millennials from renters to buyers may be the first sign of real inflation beyond the increasingly dear healthcare and higher education that we already are seeing.

And Millennials are having kids that demand a bigger living space! Who knew?

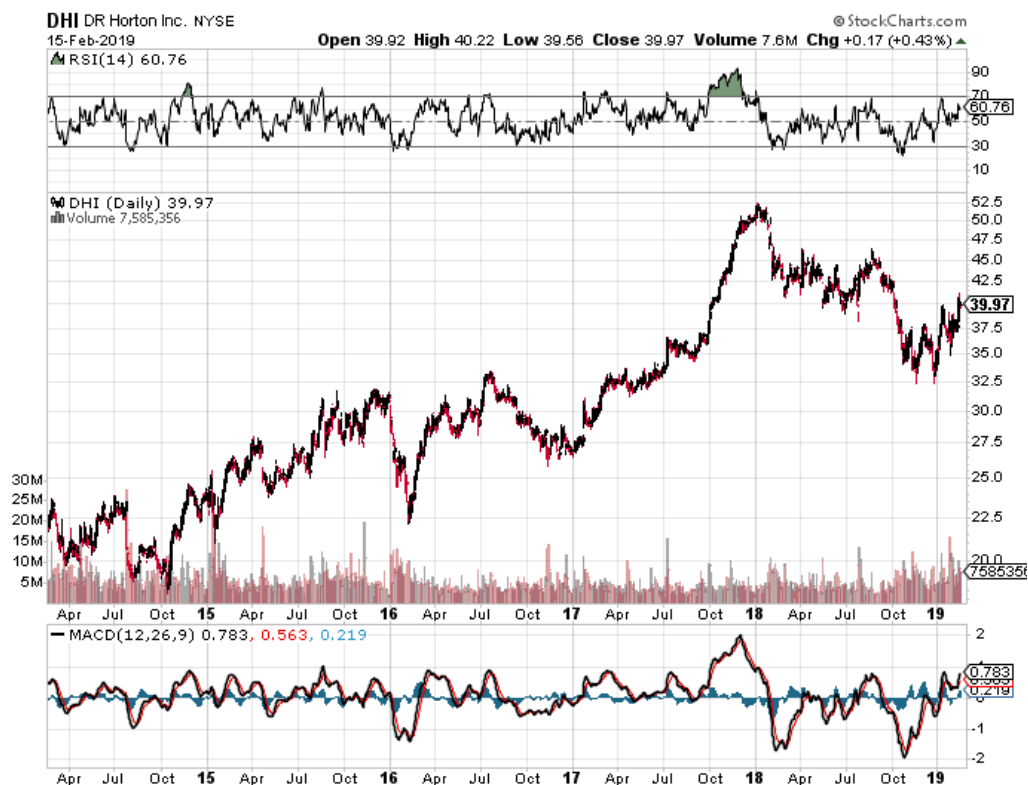

PHM PulteGroup, Inc. NYSE
15-Feb-2019

© StockCharts.com

Open 27.01 High 27.34 Low 26.85 Close 27.12 Volume 3.4M Chg +0.21 (+0.78%) ▲

▲ RSI(14) 51.71

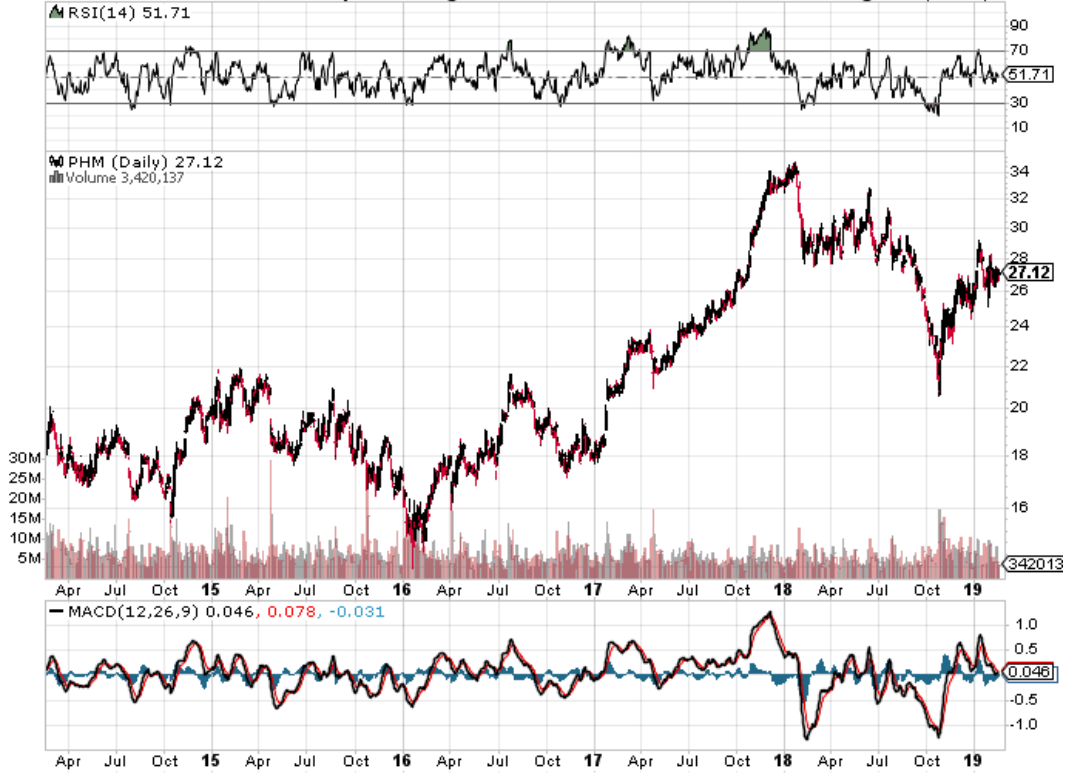

LEN Lennar Corp. NYSE
15-Feb-2019

© StockCharts.com

Open 48.62 High 49.21 Low 48.44 Close 48.90 Volume 3.6M Chg +0.66 (+1.37%) ▲

▲ RSI(14) 67.60

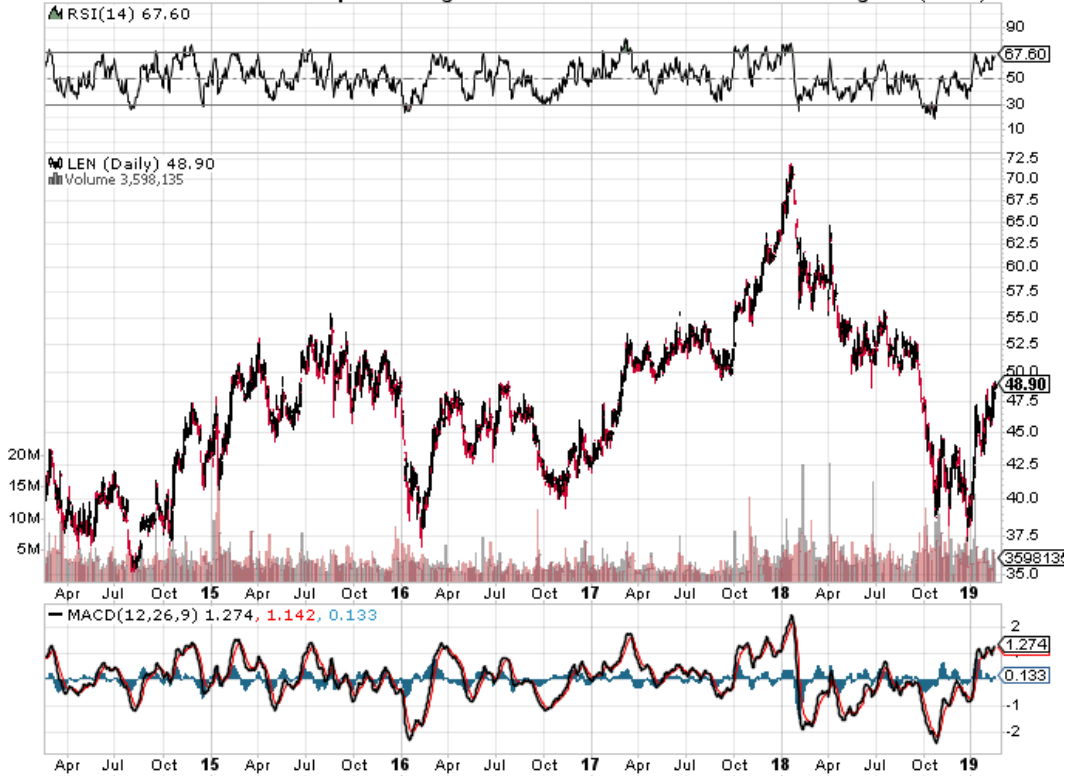



Looks Like a “BUY” to Me

Click [HERE](#) to Learn more about Mad Hedge Fund Trader and the services we offer.

Making a Fortune in Real Estate - Part II

A number of analysts, and even some of those in the real estate industry, thought that there would never be a recovery in residential real estate.

Longtime readers of this letter already know that seeing the real estate crash coming a mile off, I dumped all my properties in 2005, some \$20 million worth.

However, I believe that “forever” may be on the extreme side. Personally, I believe there will be great opportunities in real estate that run all the way until 2030.

Let's back up for a second and review where the great bull market of 1950-2007 came from. That's when a mere 50 million members of the “greatest generation,” those born from 1920 to 1945, were chased by 80 million baby boomers born from 1946-1964.

There was a chronic shortage of housing with the extra 30 million individuals never hesitating to borrow more to pay higher prices.

When my parents got married in 1948, they were only able to land a dingy apartment in a crummy Los Angeles neighborhood because my dad was an ex-Marine. This is from where our suburbs came.

Since 2005, the tables have turned. There are now 80 million baby boomers attempting to unload dwellings on 65 million generation Xers who earn less than their parents, marking down prices as fast as they can.

As a result, the Federal Reserve thinks that 20% of American homeowners still have either negative equity, or less than 10% equity, which amounts to nearly zero after you take out sales commissions and closing costs.

That comes to 30 million homes. Don't count on selling your house to your kids, especially if they are still living rent-free in the basement.

The good news is that **the next real bull market in housing started.**

The 85 million Millennials, those born from 1988 to yesterday, have started competing to buy homes from only 65 million upwardly mobile Gen Xers. Add these two generations together and you have a staggering **150 buyers competing for the same housing at the same time!**

Fannie Mae and Freddie Mac will soon be gone, meaning that the 30-year conventional mortgage will cease to exist. All future home purchases will be financed with adjustable rate

mortgages, forcing home buyers to assume interest rate risk as they already do in most of the developed world.

For you Millennials now just graduating from college, this is a best-case scenario. People will no doubt tell you that you are crazy, that renting is the only safe thing to do, and that home ownership is for suckers.

That's what people told me when I bought my first New York co-op in 1982 at one-tenth its current market price.

Just remember to sell by 2035, because that's when the next intergenerational residential real estate collapse is expected to ensue. That will leave the next yet-to-be-named generation holding the bag as your parents are now.

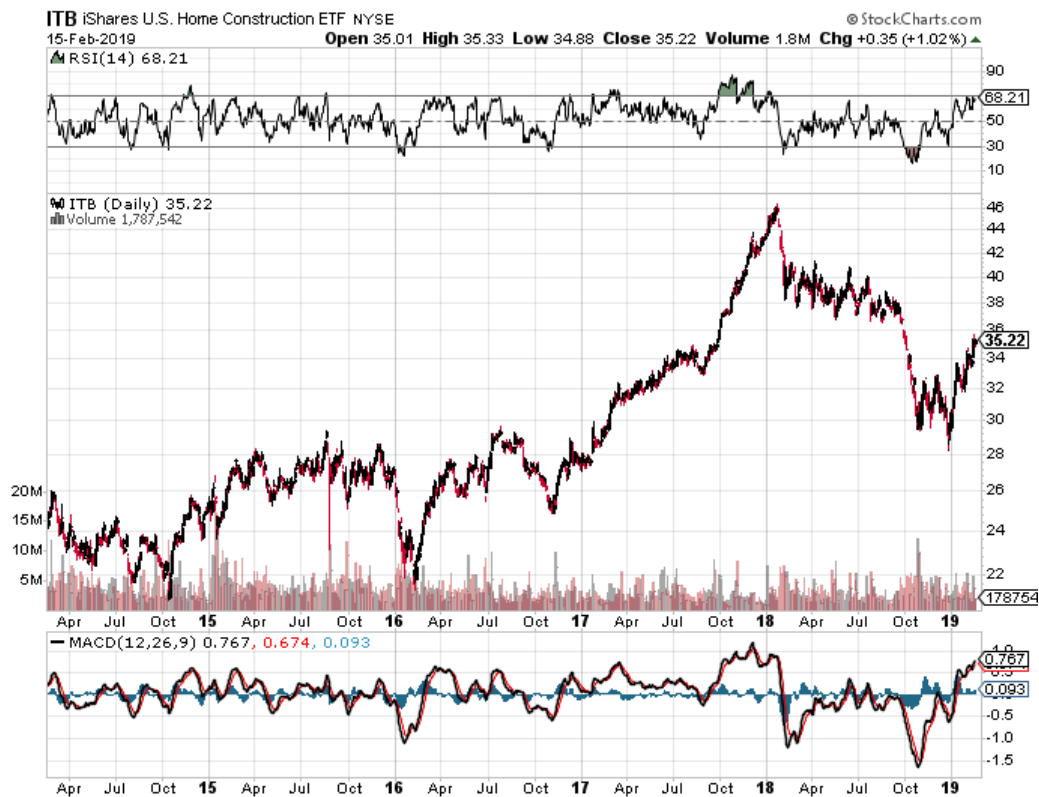

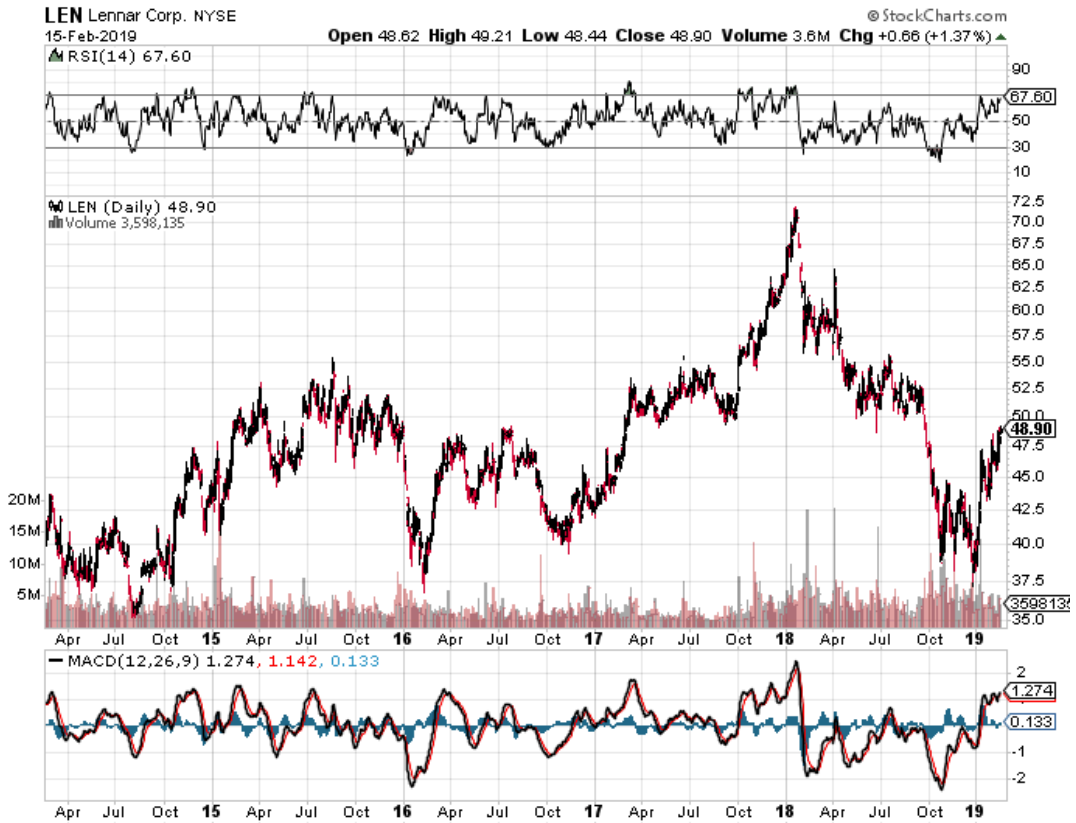
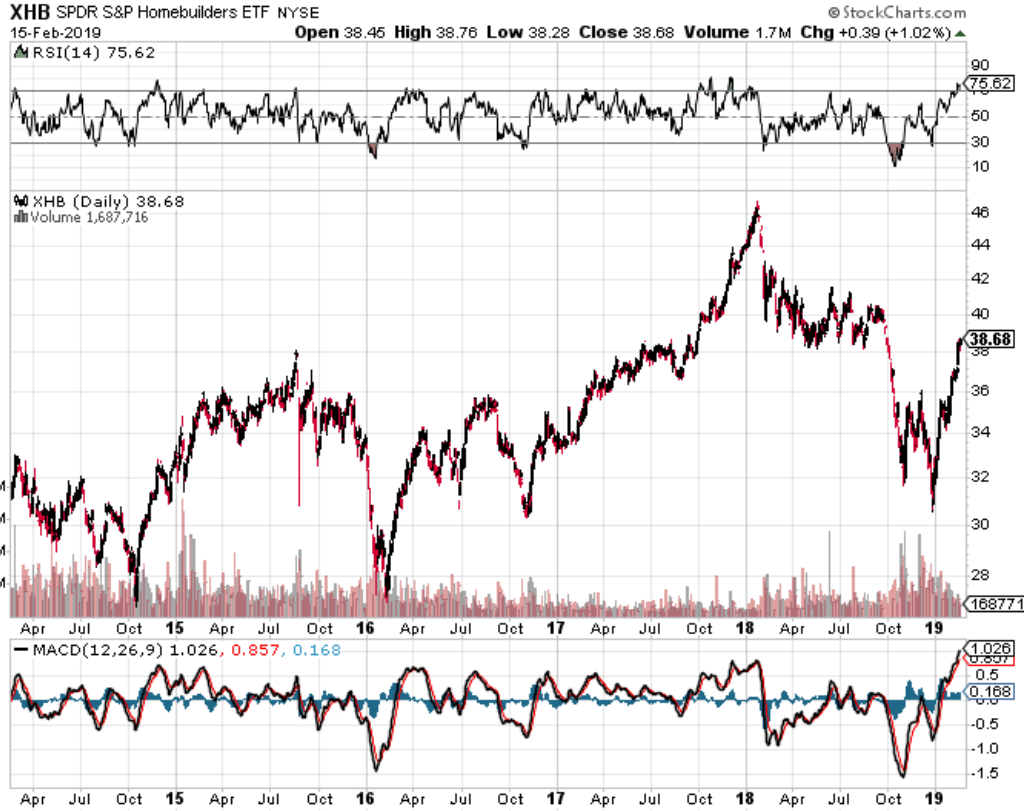



Time to Buy?

Click [HERE](#) to Learn more about Mad Hedge Fund Trader and the services we offer.

Making a Fortune in Real Estate - Part III

Is gold your best-performing asset for the next five years? Is it high-growth technology stocks? Energy stocks? Or maybe biotech shares?

How about French collectible postage stamps or vintage racing cars?

Nope, you're not even close. I'll give you a hint: You're probably sitting in it.

Yes, the best-performing investment you will own for the next five years will most likely be the home you live in.

Psshaw, you may say. Perhaps even balderdash! However, if you look at the crucial data that drives this long-ignored sector, my conclusions are unassailable.

If fact, you can pretty much count on your home to appreciate at a 3% to 4% annual rate until well into the next decade and more if you are fortunate enough to live on the red hot West Coast. Net out the copious tax breaks that come with homeownership, and your take-home will be even higher than that.

This beats the daylight out of stocks (SPY) (1.90% yield), 10-year Treasury bonds (TLT) (2.70%), and approaches junk bonds (HYG) (5.31%) in terms of the potential returns.

For a start, the Federal Reserve's go-slow policy on interest rate rises is hugely pro housing. The conventional 30-year fixed home mortgage can be had for a bargain 4.7%. And many finance their properties with the 5/1 ARMs that I have been recommending which are currently going for only 4%.

Worried about what happens in the next several years when the interest rate is reset? Just refinance during the next recession, which will almost certainly happen before then, and you'll probably get a lower rate than you can get now.

That is, assuming you still have a job.

The good news for those homeowners who rely on the floating rates of an adjustable rate mortgage is that this is not a low interest rate decade, but a low interest rate century.

Another positive is weekly jobless claims averaging at 210,000 a month, and unemployment rate of 4.0%, meaning that a lot more people have the income with which to purchase homes, far more than only a couple of years ago.

And how about those energy prices? Even after this year's prolific rally, gasoline prices are still 50% lower than they were two years ago. My eyes almost popped out of my head when I saw gas for sale in South Carolina at \$1.39 a gallon two weeks ago.

Cheap fuel means that consumers have more money in their pockets with which to qualify for loans, buy houses, and meet their mortgage payments.

Not only will this be a low interest rate century, it will be a low energy cost century as well. If solar energy costs continue their dramatic rate of improvement, around 50% every four years, it will nearly be free by 2030.

Not only will free energy provide a big underpinning under home values. It will also increase the value of suburban homes where commuting is a major factor.

It gets better.

You know that Millennial of yours who's been living in your basement since he graduated from college? Go downstairs and take a look. Chances are he probably moved out when you weren't looking, turning his prodigious gaming skills into a high-paying coding job.

What's more, he's now dating a girl. You know, the one with the nose ring, the streak of purple hair, and tattoos up and down both arms?

That leads to family formation. And you know what? The most important trend affecting the economy that no one knows about is that **THE UNITED STATES IS ABOUT TO ENJOY ANOTHER BABY BOOM!**

However, only 1 million homes a year are being built, thanks to the halving of construction capacity in the aftermath of the Great Recession. Subtract from that 250,000 houses a year that get demolished.

Does anyone hear the words "short squeeze"?

That means 85 million Millennials will be chasing the homes of only 65 Gen Xers. Here in the San Francisco Bay Area they are showing up at weekend open houses and paying cash for beautiful \$3 million homes with great views, writing the check right on the spot.

Americans aren't the only ones buying homes. Some 8% of all the real estate sold in the U.S. in 2015 was to foreign investors, largely Chinese and Hispanic, according to the National Association of Realtors. That is an all-time high. They view U.S. real estate as a great asset protection strategy.

It is not entirely a bed of roses for housing. The new tax bill eliminated the deductibility of local real estate taxes. All other tax increases will be aimed at the 1%.

Are you convinced now? Are you ready to jump into the real estate boom and participate more than just through your residence?

Fortunately, there are a number of ways you can achieve this.

Residential Real Estate Investment Trusts (REITs) offer the opportunities of both a high-yield and capital appreciation.

Better yet is that all of these trade at deep discounts to book values because of fears about future interest rate rises. They include AvalonBay Communities, (AVB) (3.11% yield) and Camden Property Trust (CPT) (3.25%).

You can also go into traditional new home builders such as KB Homes (KBH), Pulte Homes (PHM), and D.R. Horton (DHI). Another option is to take a basket approach by picking up the iShares U.S. Home Construction ETF (ITB).

See you at the next open house!

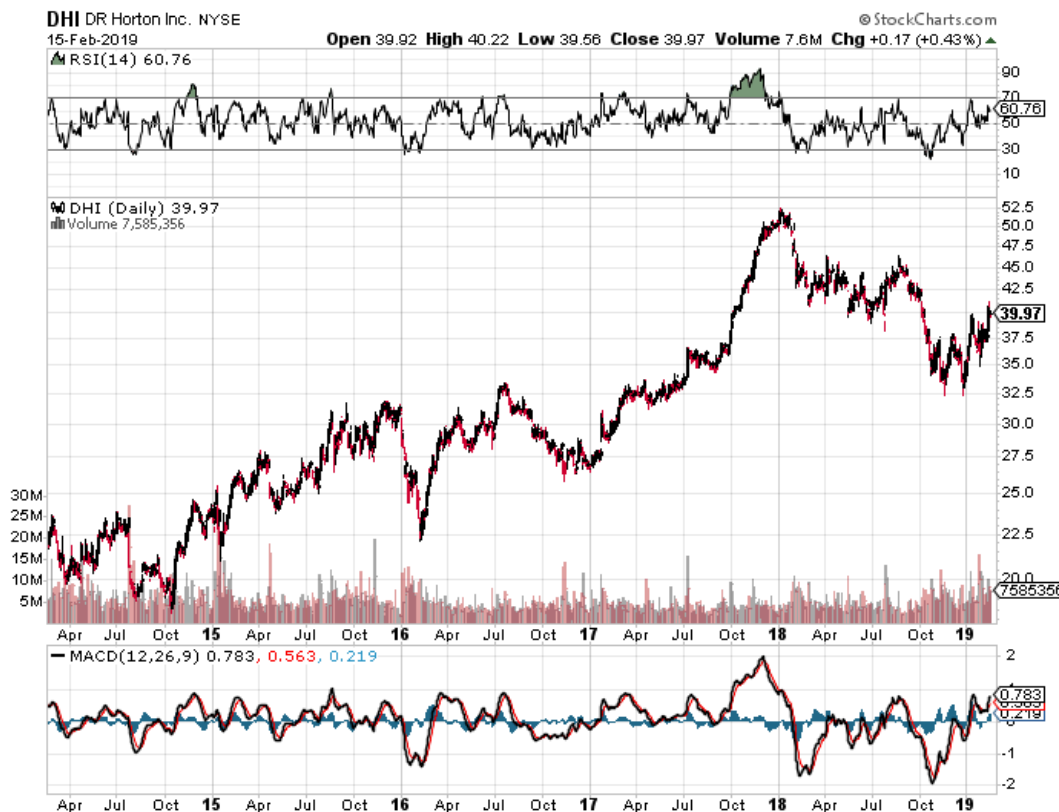

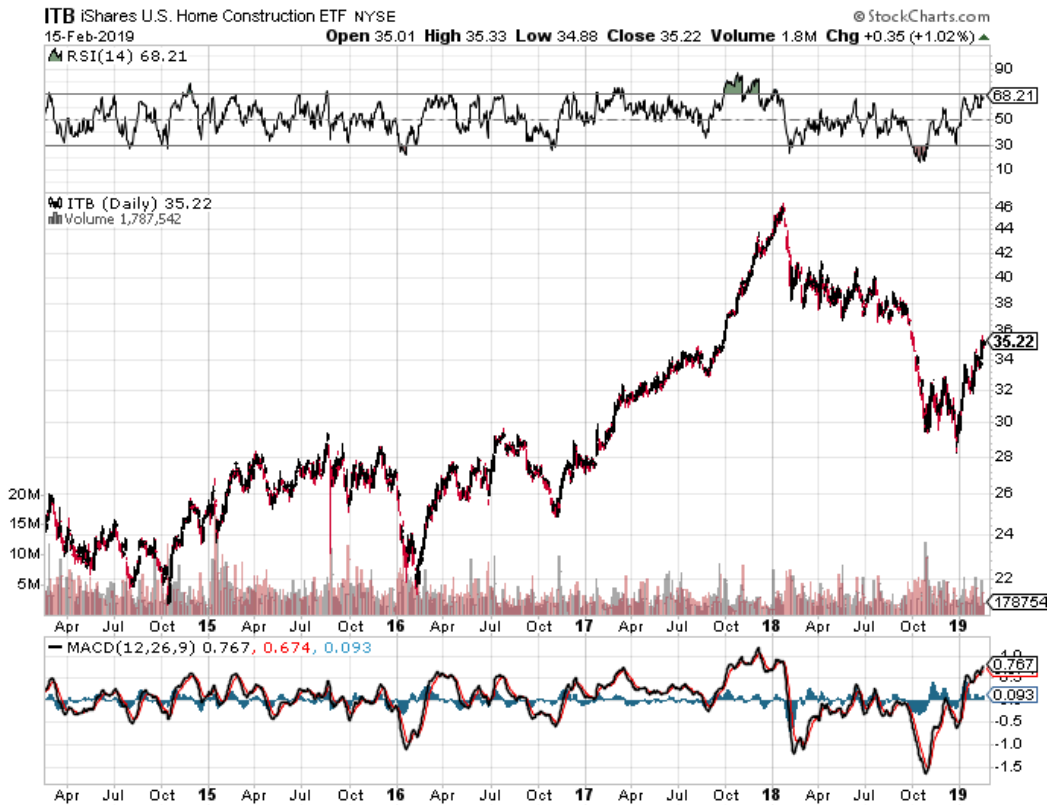
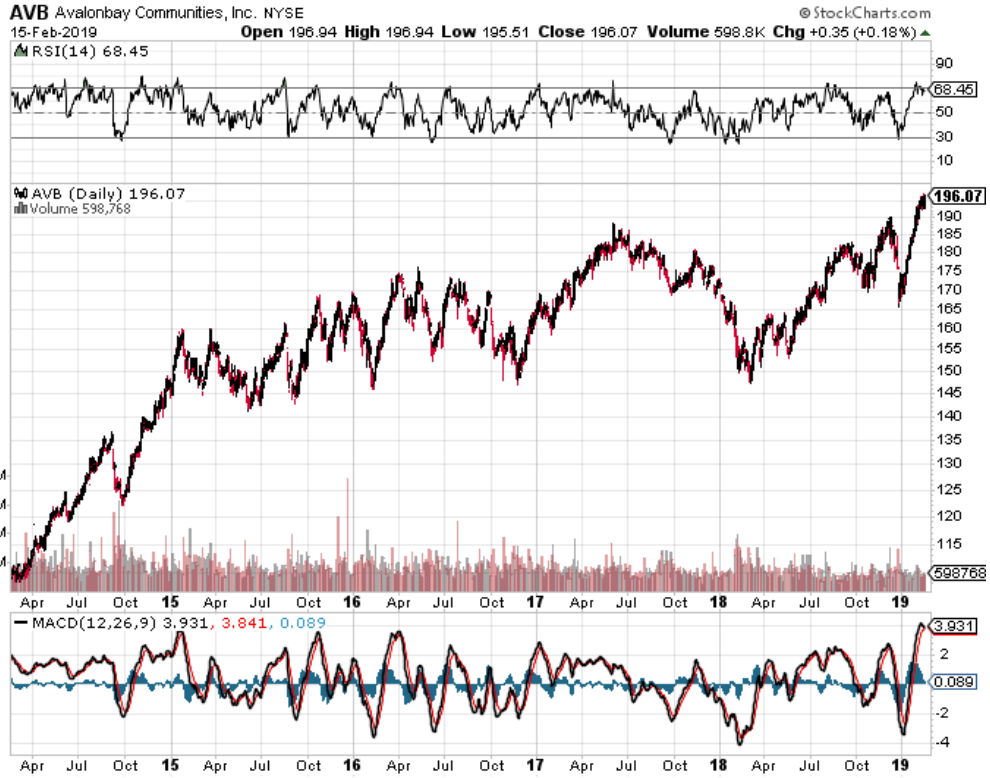

Figure 1: Households' home equity wealth has nearly recovered to its peak, while they now also save money at the gas pump

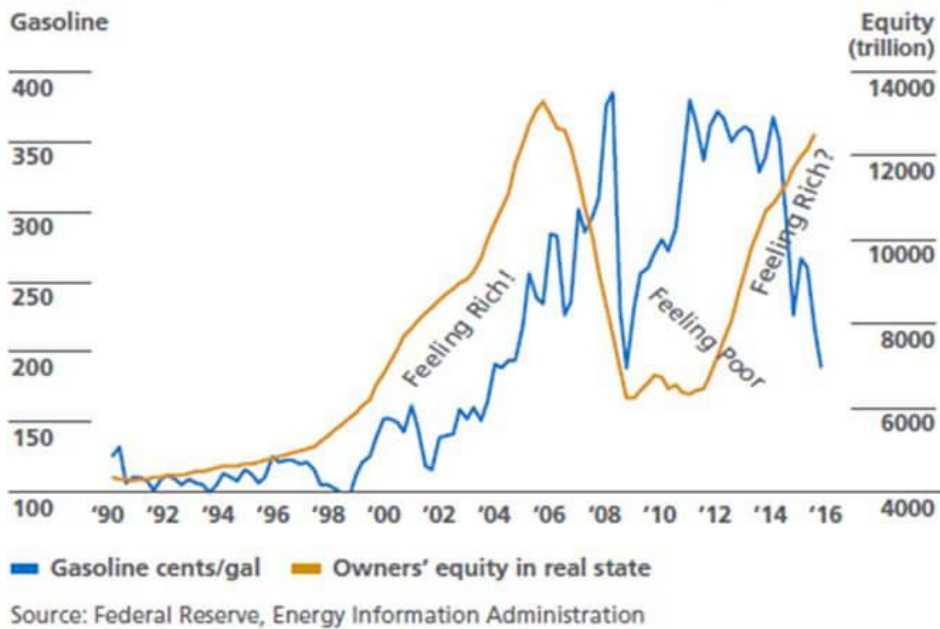

Figure 2: Foreign homebuyers are approximately 8% of U.S. transaction volume

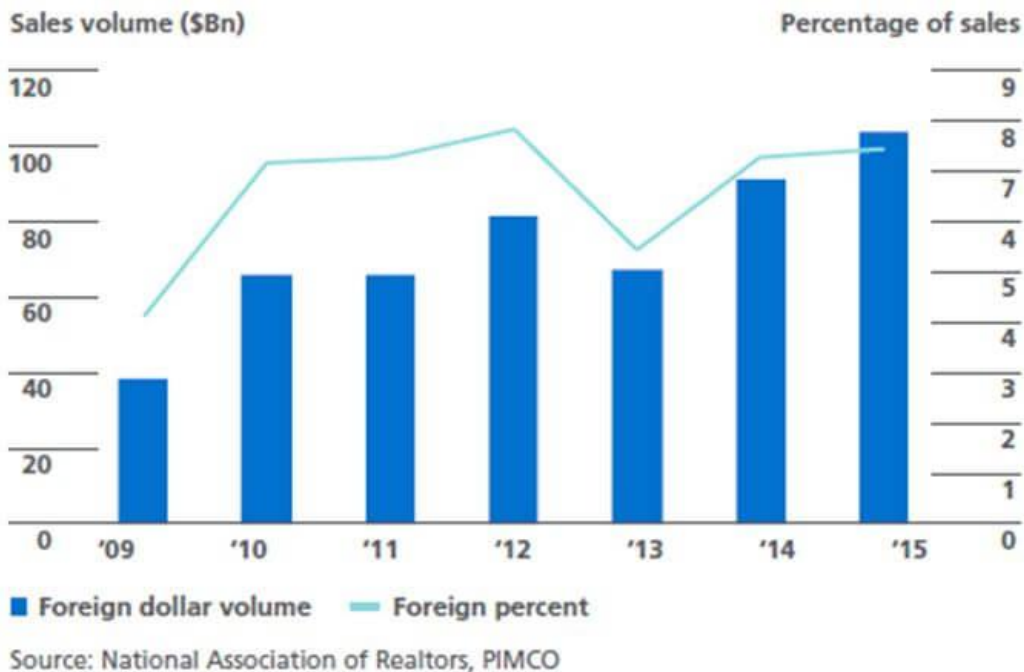
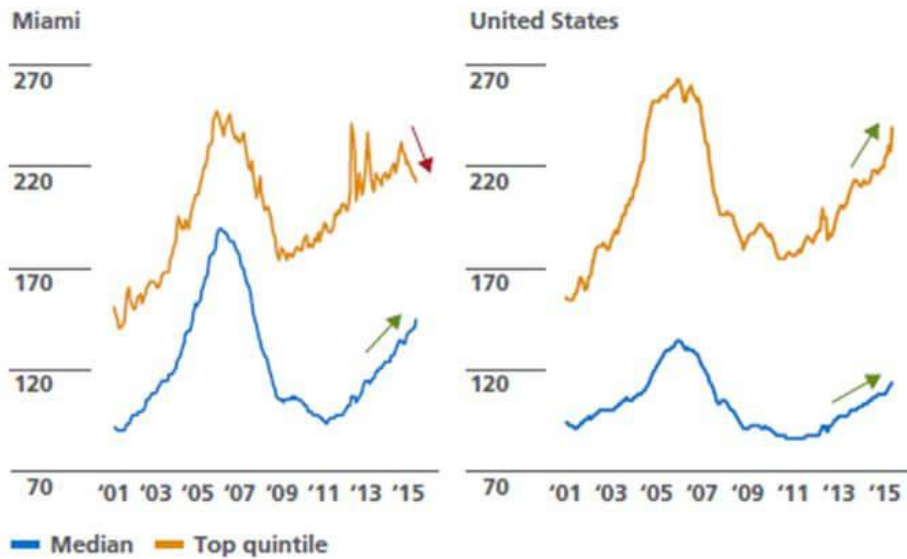

Figure 3: Home prices have fallen in Miami's top tier, but other tiers and the national index are unaffected



Source: Corelogic, PIMCO as of March 2016

Figure 4: Construction typically runs above household formation due to the need for demolitions, but now households are forming faster than homes are being built

Housing Completions: Total SAAR, Thous. units

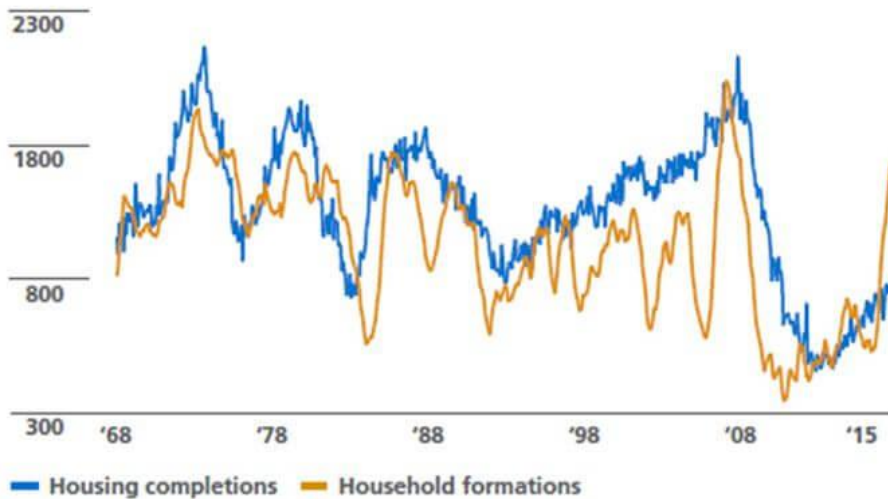

Source: Census Bureau



Click [HERE](#) to Learn more about Mad Hedge Fund Trader and the services we offer.

The Second Industrial Revolution

Circulating among Europe's top global strategists last year, visiting their corner offices, camping out in their vacation villas, or cruising on their yachts, I am increasingly hearing about a new investment theme that will lead markets for the next 20 years: The Second American Industrial Revolution.

It goes something like this...

You remember the first Industrial Revolution, don't you? I remember it like it was yesterday. It started in 1775 when a Scottish instrument maker named James Watt invented the modern steam engine. Originally employed for pumping water out of a deep Shropshire coal mine, within 32 years it was powering Robert Fulton's first commercially successful steamship, the Clermont, up the Hudson River.

The first Industrial Revolution enabled a massive increase in standards of living, kept inflation near zero for a century and allowed the planet's population to soar from 1 billion to 7 billion. We are still reaping its immeasurable benefits.

The Second Industrial Revolution is centering on my own neighborhood of San Francisco. It seems like almost every garage in the city is now devoted to a start-up. The cars have been flushed out onto the streets, making urban parking here a total nightmare. These are turbo charging the rate of technological advancement.

Successes go public rapidly and rake in billions of dollars for the founders overnight. Thirty-year-old billionaires are becoming common.

However, unlike with past winners, these newly minted titans of industry don't lock their wealth up in mega mansions, private jets, or the Treasury bond market.

They buy a Tesla Model S-1 (TSLA), and then reinvest the rest of their windfall in a dozen other start-ups, seeking to repeat a winning formula.

Many do it.

Thus, the amount of capital available for new ideas is growing by leaps and bounds. As a result, the economy will benefit from the creation of more new technology in the next 10 years than it has seen in the past 200.

Computing power is doubling every year. That means your iPhone will have a billion times more computing power in a decade. 3-D printing is jumping from the hobby world into large-scale

manufacturing. In fact, Elon Musk's SpaceX is already making rocket engine parts on such machines.

Drones came out of nowhere and are now popping up everywhere.

And don't get me started on virtual reality. Ever wanted to date Cybill Shepherd or Nicole Kidman? How about both, at the same time? The possibilities boggle the mind.

It is not just new things that are being invented. Fantastic new ways to analyze and store data, known as "big data," are being created.

Unheard of new means of social organization are appearing at breakneck speed leading to a sharing economy. Much of the new economy is not about invention but organization.

The Uber taxi service has created \$65 billion in market capitalization in only five years and is poised to replace UPS, FedEx, and the U.S. Postal Service with "same hour" intra-city deliveries. Now it is offering "Uber Eats" in my neighborhood which will deliver to you anything you want to eat, hot, ***in 10 minutes!***

Airbnb is arranging accommodation for 1 million guests a month, including 120,000 in Brazil for 2014 World Cup. They even had 189 German guests staying with Brazilians. I bet those were interesting living rooms on the final day! (Germany won).

As for me, I am planning my own all-Airbnb trip to Europe next summer. It should be interesting.

And you are going to spend a lot of Saturday nights at home alone if you haven't heard of Match.com, eHarmony.com, or Badoo.com.

Biotechnology (IBB), an also-ran for the past half-century, is sprinting to make up for lost time. The field has grown from a dozen scientists in my day 40 years ago to several hundred thousand today.

The payoff will be the cure of every major disease, such as cancer, Parkinson's, heart disease, AIDS, and diabetes, within 10 years. Some of the harder cases, such as arthritis, may take a little longer. Soon, we will be able to manipulate our own DNA at will.

The upshot will be the creation of a massive global market for these cures, generating immense profits. American firms will dominate this area, as well.

Energy is the third leg of the innovation powerhouse. Into this basket you can throw in solar, wind, batteries, biodiesel, and even "new" nuclear. The new Tesla home battery will be a game changer. Visionary Elon Musk, co-founder of Tesla, is ramping up to make tens of millions of these things.

The message to big oil is that Musk sold 400,000 of his new Tesla 3s in just two weeks, and that is for a car that won't be delivered for two more years.

Use of existing carbon-based fuel sources such as oil and natural gas will become vastly more efficient. Fracking is unleashing unlimited new domestic supplies at costs that are falling at an incredible rate.

Welcome to "Saudi America."

The government has ordered Detroit to boost vehicle mileages to an average of 55 miles per gallon by 2025. The big firms all have told me they plan to beat that deadline, not litigate it – a complete reversal of philosophy.

Coal will be burned in impoverished emerging markets only before it disappears completely. Energy costs will drop to a fraction of today's levels further boosting corporate profits.

If you thought the Internet was big, free energy will have a far greater impact on the global economy.

Coal will die not because of some environmental panacea, but because it is too expensive to rip out of the ground and transport around the world when all of the costs are factored in.

Seven years ago, I used to get two pitches for venture capital investments a quarter, if any. Now, I am getting two a day. I can understand only half of them (those that deal with energy and biotech, and some tech, where I have a background).

My friends at **Google Venture Capital** are getting inundated with 20 a day **each!** How they keep all of these stories straight is beyond me. I guess that's why they work for Google (GOOGL).

The rate of change for technology, our economy, and for the financial markets will accelerate to more than exponential.

It took 32 years to make the leap from steam engine-powered pumps to ships, and was a result of a chance transatlantic trip by Robert Fulton to England where he stumbled across a huffing and puffing steam engine.

Such a generational change is likely to occur in 32 minutes in today's hyper-connected world, and much shorter if you work on antivirus software (or write the viruses themselves!).

The demographic outlook is about to dramatically improve, flipping from a headwind to a tailwind in 2022. That's when the population starts producing more big spending Gen Xers and

fewer oversaving and underproducing baby boomers. This alone should add at least 1% to 2% a year to GDP growth.

China is disappearing as a drag on the U.S. economy. During the 90s and the naughts, they probably sucked 25 million jobs out of the U.S.

With an “onshoring” trend now in full swing, the jobs ledger has swung into America’s favor. This is one reason that unemployment is steadily falling. Joblessness is becoming China’s problem, not ours.

The consequences for the financial markets will be nothing less than mind-boggling. The short answer is higher for everything. Skyrocketing earnings take equity markets to the moon.

Multiples blast off through the top end of historic ranges. The U.S. returns to a steady 4% a year GDP growth in the 2020s.

What am I bid for the Dow Average (INDU), (SPY), (QQQ) in 2030? Did I hear 300,000, a 17-fold pop from today’s level? Or more?

Don’t think I have been smoking the local agricultural products in arriving at these numbers. That is exactly the gain that I saw during 1982 to 2000, when the stock average also appreciated 17-fold, from 600 to 10,000.

They’re playing the same movie all over again. Except this time, it’s on triple fast forward.

There will also be commodities (DBA) and real estate booms. Even gold (GLD) gets bid up by emerging central banks bent on increasing their holdings to western levels.

I tell my kids to save their money, not to fritter it away on day trading now, because anything they buy in 2020 will increase in value tenfold by 2030. They’ll all look like geniuses, like I did during the 80s.

After that, I will be 78, and it will be up to them to figure out what is going to happen next. What are my strategist friends doing about this forecast? They are throwing money into U.S. stocks with both hands, especially in technology (XLK), biotech (IBB), and energy (XLE).

This could go on for decades.

Just thought you’d like to know.



It's Amazing What You Pick Up on These Things!

Click [HERE](#) to Learn more about Mad Hedge Fund Trader and the services we offer.

The Quantum Computer in Your Future

When I was a kid, radios were built with vacuum tubes.

I remember my dad taking me to the supermarket where a large display case sporting dozens of sockets identified the tube you needed.

All you had to do then was install it without electrocuting yourself.

Then transistors were invented, and everything changed overnight. Suddenly, solid-state electronics took over the market. Everything was lighter, cheaper, and much faster.

A decade later, Intel took over the computer market launching its revolutionary 4004 microprocessor.

It looks like I am going to live long enough to see another great leap forward in computing power.

Imagine a single computer that was so powerful that its processing power exceeded that of all the other computers in the world combined.

Applied to the stock market, such a machine would be able to algorithmically extract hundreds of billions of profits without anyone noticing.

It would be able to break any code in the world in seconds rendering all security programs useless.

It would also act as an adrenaline shot for all of the artificial intelligence efforts currently out there.

Oh, and to understand how to interpret its output, we will have to invent a new form of advanced high mathematics.

You may be forgiven for thinking I spent my weekend reading science fiction.

But you would be wrong.

I actually got to see a working prototype for such a machine known as a quantum computer at the NASA's Ames Research Center in nearby Mountain View, California.

Dominated by an enormous wooden airship hangar once owned by the Navy, the facility is home to a joint venture between NASA and Google to develop the next generation of supercomputers.

The machine was built by D-Wave, a small Canadian start-up in Burnaby, a suburb of Vancouver, Canada. It was founded in 1999 by former wrestler, Geordie Rose, and Haig Ferris.

To understand how such a breakthrough is possible, it is necessary for me to explain some basic particle physics.

Classical computers operate through a system of silicon gates that allow electrons to pass through or not. This is expressed in computer code as a 0, a 1, or nothing at all, known as “bits.”

And yes, I am old enough to have programmed simple computers with only 0s and 1s.

The problem is that this technology, launched during the 1960s, is reaching its theoretical limits.

According to Moore’s law, the number of circuits squeezed on a microprocessor doubles every two years until 2015. A few ingenious tweaks and modifications by manufacturers have extended that deadline by five years to 2020.

After that, a Great Depression was supposed to hit, as all progress in technology ground to a halt.

Enter quantum computing.

Instead of only two possible choices in each code entry, the number of possible solutions becomes infinite for quantum computing.

It does this by changing the physical statue of electrons for each piece of code. Some electrons spin clockwise, others counterclockwise, while others still spin on a Northeast-Southwest axis, and so on.

As a result, the number of calculations that can be performed by a quantum algorithm increased exponentially, as does its speed.

The computational unit of a quantum computer is called a “quantum bit,” or “qubit.”

The machine I saw has 1,000 qubits, powered by two chips containing 500 niobium loops each, and was code named “Washington.”

The quantum computer I saw doesn’t look anything like a computer. Instead, it looks like a small walk-in freezer.

That is essentially what it is, as 90% of the hardware is devoted to dissipating heat and shielding it from electromagnetic and magnetic interference.

There is no silicon involved in this computer. Instead, the chips are made of hundreds of 2 micron-wide threads of niobium, a rare earth, cooled at close to absolute zero.

Gold-plated copper disks are used as heat sinks.

The next generation quantum computer is expected to have chips made out of aluminum.

The quantum code is now so fragile that the mere presence of matter can erase it and convert it

into a useless classical computer.

Its speed is measured through a process known by “entanglement” whereby distant atoms display the mirror image of nearby ones.

And now we’re over my pay grade, and probably yours, too.

For that reason, its output can only be transmitted through fiber optic cable.

D-Wave is not alone in its efforts at quantum computing. Do any search on the term, and the numbers of research institutions involved runs into the hundreds. And who knows what is going on in China and Russia?

D-Wave is a private company. Its largest investors include venture capital firm Draper Fisher Jurvetson, Amazon’s Jeff Bezos, and In-Q-Tel, the venture capital arm of the CIA.

It is possible that D-Wave may never see the light of day as a public company in which you and I can invest. Instead, its total production may be reserved for its original investors.

However, you can invest directly into those shareholders most likely to benefit, including Amazon (AMZN) and Alphabet (GOOG).

There are other models for advanced supercomputing underway that also may reach economic viability, such as DNA-based computing. I’ll be covering those in a future letter.

One of the many goals of the *Diary of a Mad Hedge Fund Trader* is to discover advanced technologies early, and then get out in front of them with trading recommendations.

Ever wonder why Amazon shares have tripled this year?

This might be the reason.

To learn more about D-Wave and its amazing technology, please [click here](#).

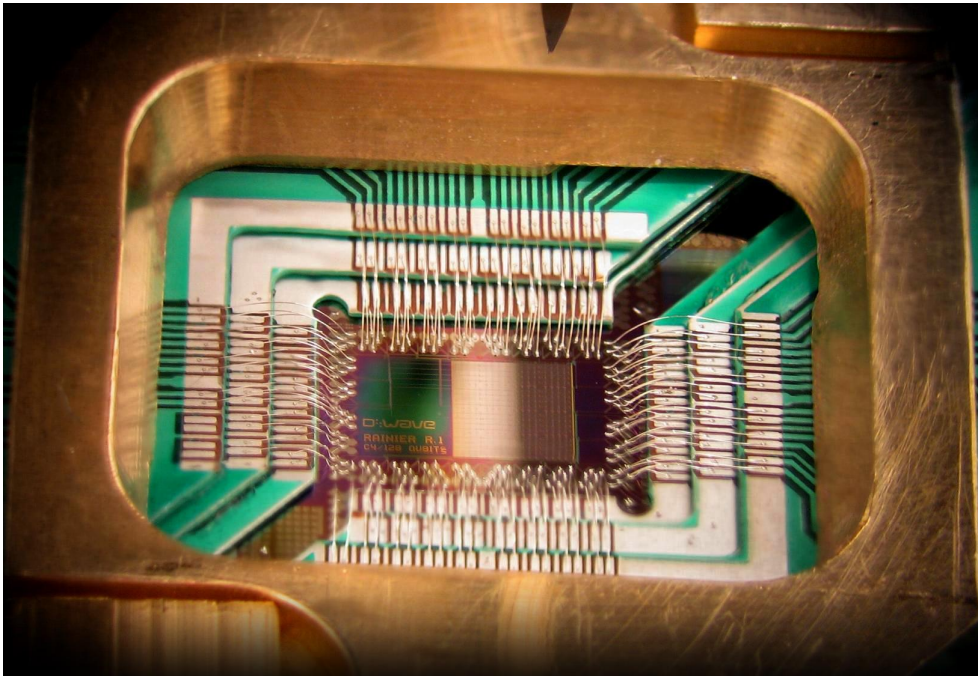

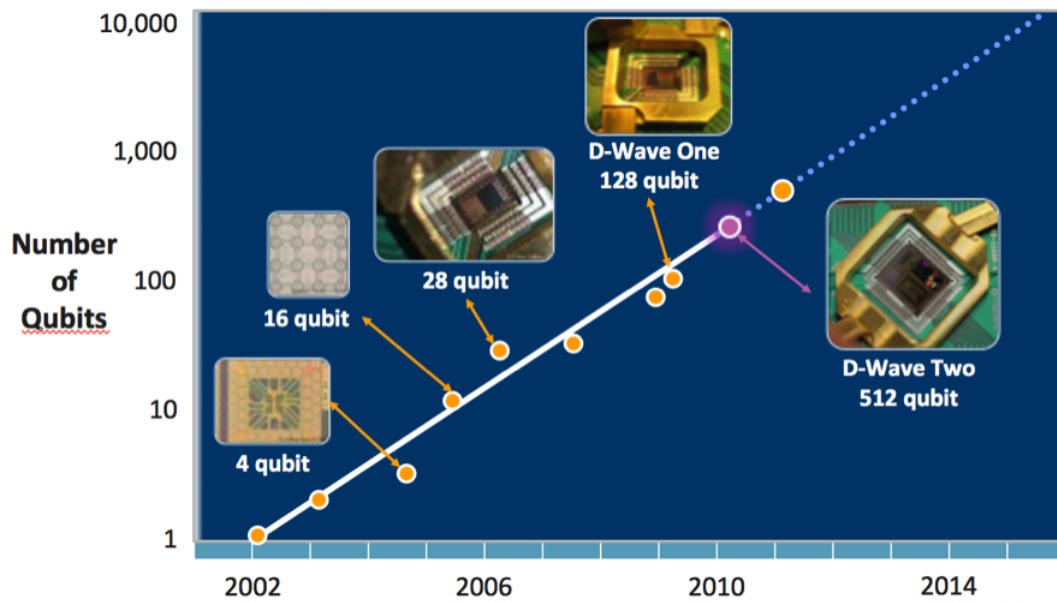
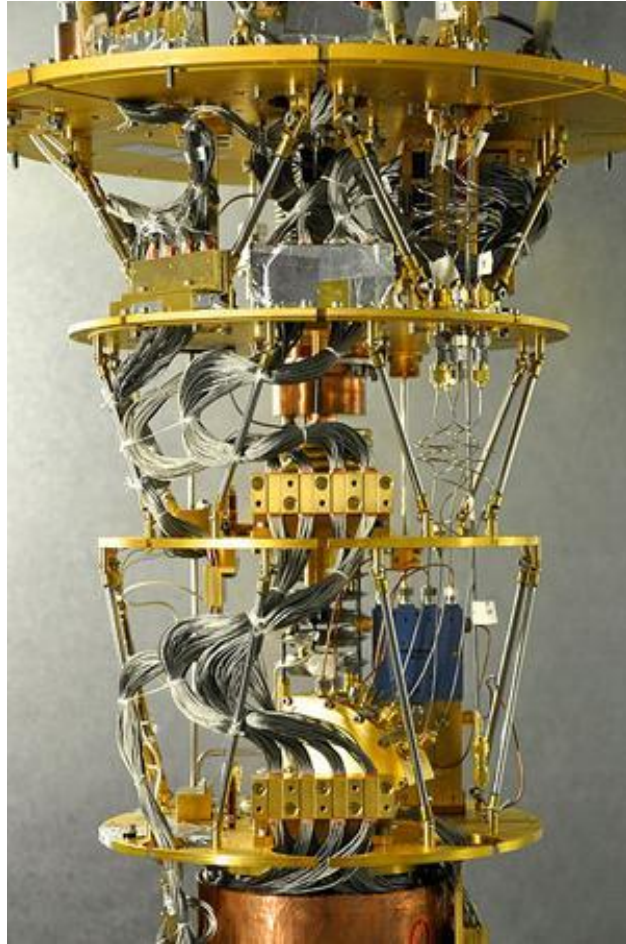

Click [HERE](#) to Learn more about Mad Hedge Fund Trader and the services we offer.

The Great Artificial Intelligence Stock Play You've Never Heard Of

I have been covering Silicon Valley since it was a verdant, sun-kissed peach orchard in Northern California.

When Apple cofounder Steve Wozniak was president of the Homestead High Radio Club, I used to polish my Morse code skills communicating with him at night on my own homebuilt, tube-powered radio.

After Apple (AAPL) went public in 1980, it was my job at Morgan Stanley to take a young, blue jean-clad Steve Jobs around to visit the big New York institutional investors.

After all, I was one of only three Californians then working at that prestigious private investment bank.

It was the worst day of my life. Jobs was not exactly “Mr. Congeniality.”

And whenever I had time to kill at Morgan Stanley, I would walk down a floor to the fixed income research department and debate long tail mathematics with some geek named Jeff Bezos.

A bookstore, Jeff, really? You've got to be kidding me!

I have to say that in the half century that I have followed the technology industry, I have never seen the principals, gurus, and visionaries so excited about a major new trend.

That would be artificial intelligence, or A.I.

Asking if A.I. is relevant now is like pondering the future of Thomas Edison's new electricity in 1890.

If you think that A.I. still belongs in the realm of science fiction, you obviously didn't get the memo. It is all around us all the time, 24/7. You just don't know it yet.

A.I. passed out of the world of **2001: A Space Odyssey** HAL 9000, Fritz Lang's **Metropolis**, and the Arnold Schwarzenegger portrayed **Terminators** a long time ago.

When my pre-teen girls got iPhones for Christmas years ago, the first question they asked the built-in A.I. assistant **Siri** was “Do you have a boyfriend?”

(Answer: “Why, so we can get ice cream together, listen to music, and travel across galaxies, only to have it end in slammed doors, heartbreak, and loneliness? Sure, where do I sign up?”)

Apparently, Siri has had some unhappy experiences with men.

Ask Siri the same question today, and you get a different answer. **Siri** is learning.

If you really want to be impressed by A.I., jump into my new self-driving Tesla Model X SUV.

I have been driving cars for 50 years, and the Model X is far more skilled than I am.

It stays perfectly centered in a lane at all times. If someone pulls in front of you, it automatically slows down to a regulation safe distance.

Touch the turn signal, and it will perfectly move into the adjacent lane, but only when it is prudent to do so.

So far, Teslas have driven 100 million miles on autopilot, resulting in only one death.

That amounts to a 50% reduction in the fatality rate for driving cars. Translate that nationally, and it would cut the U.S. automotive death rate by half, saving 15,000 lives a year.

And we are still in the very early days of this technology. Ultimately, the death rate should be zero. Emergency rooms would go out of business.

It helps that A.I.-driven cars don't drink, do drugs, have bad moods, want to race each other, or in my case, suffer from the failing eyesight and slowing reflexes that come with age.

And here's the scary part.

Friends of mine in senior management at Tesla (TSLA) who have been using the self-driving cars for two years tell me that since each vehicle has a unique learning experience, they are developing different personalities.

In other words, ***they are becoming human!***

Recently, Tesla announced that its revolutionary full autopilot is installed in all of its cars now. The company plans to allow a Model S-1 to drive from Los Angeles to New York, ***BY ITSELF***.

Expect the move to be accompanied by a lot of promotion and hoopla. It could also spark a new investment boom in A.I. stocks.

And here's the rub.

It is impossible to invest purely in A.I.

All new A.I. start-ups comprise small teams of experts from labs and universities financed by big venture capital firms such as Sequoia Capital, Kleiner Perkins, and Andreessen Horowitz.

After developing software for a year or two, they are sold on to major technology firms at huge premiums. They never see the light of day in the form of a public listing.

Alphabet (GOOG) acquired Britain-based, DeepMind in 2014. Later that year, Google's AlphaGo

program defeated the world's top-ranked Go player.

Last year, Microsoft (MSFT) purchased Equivio, a small firm that applies A.I. to advanced document searches on the Internet.

Amazon (AMZN) recently bought out Orbeus, a start-up known for machine learning tools for image recognition.

Amazon's Jeff Bezos now says that his **AmazonFresh** home food delivery service is using A.I. to grade strawberries.

Really!

We're not talking small potatoes here.

The global artificial intelligence market is expected to grow at an annual rate of 44.3% a year to \$23.5 billion by 2025.

Nearly half of all applications now use some form of A.I. that by 2020 will earn businesses an extra \$60 billion a year in profits.

And from what I have learned from speaking to the major players, I am convinced that these are low numbers by an order of magnitude.

I have been following developments in artificial intelligence since the 1960s.

There were those feeble computer dating attempts in the early 70s where we all had to prepare IBM punch cards.

I was matched with an annoyingly aggressive real estate agent. (Really?). Her only real qualification was that she was female.

It took decades and tens of thousands of programming man-hours before IBM's Deep Blue could become a chess grandmaster in 1996, defeating Garry Kasparov.

Big Blue's latest effort came to us with **Watson** in 2007, an 85,000-watt behemoth with 90 servers and 15 terabytes of data, or three quarters of the content of the entire Library of Congress.

The machine can read a staggering **1 million books a second**. IBM has so far poured \$15 billion into the project.

In 2011, Watson defeated the top-rated **Jeopardy** game show contestant by answering the question "What city's national museum lost the "Lion of Nimrod." The answer was "What is Baghdad" (I knew that!).

Today, Watson is on loan to the University of North Carolina at Chapel Hill where it has been deployed to cure cancer.

It took scientists a week to teach Watson how to read medical literature. In the second week, it read every paper published on cancer, some 25 million.

By the third week it was proposing customized cures for advanced cancer patients which achieved a 33% success rate.

After all, it can read all of the 8,000 cancer papers that are published every day from around the world **IN SECONDS!**

Scientists say that Watson has so far reached only 1% of its true potential.

It gets better than that.

A clinic can now biopsy your tumor, sequence its DNA, design a custom protein that will target and destroy your personal tumor, mass produce it, inject it in your tumor, and cure you of cancer in a month.

This is being done with human volunteers in clinical trials **NOW.**

Expect this procedure to go retail in about 10 years. And by that I mean cheap, locally available, and covered by your health insurance policy.

Only recently, we learned that cancer occurs at the cellular level decades before tumors can be discovered with our current primitive devices.

By the 2020s, new toilets will come equipped with sensors and chips loaded with every cancer genome known to man.

When your toilet discovers a known fragment of DNA, it will email you a warning that it is time to visit the doctor and include the entire genetic code of the cancer with which it has to be dealt.

I believe that Watson, and its future offspring, will cure the major human maladies within a decade. My generation will probably be the last to suffer serious disease.

It isn't just Watson that will take us the great leap forward in computing. In the next year or so, you will be able to buy a low-end laptop for \$500 that can hold **ALL KNOWLEDGE ACCUMULATED IN HUMAN HISTORY!**

They better hurry. That body of knowledge is doubling every 18 months!

It is a key part of my argument that the U.S. will enjoy a Golden Age and see a return of the "Roaring Twenties" during the 2020s.

A.I. is now deciding the outcome of political campaigns.

The party that figured out that a **"Donate Now and Receive a Free Gift"** button on a fundraising website raises vastly more money than a **"Contribute Now"** button wins in the

popular vote in six out of the past seven presidential elections. Thank A.I.

A.I. is now dictating campaign schedules, and even determining the content of candidate speeches.

So don't be surprised when you hear the speech on jobs in Michigan, Social Security in Florida, immigration in Arizona, and the copyright protection in Los Angeles.

Notice how certain hot button keywords come out of nowhere and are then endlessly repeated in the political media? That is all A.I.

If you have in any way been involved in the stock market for the past five years, A.I. has invaded your life.

High frequency trading and hedge funds now account for 70% of the daily trading volume on the major stock exchanges, and almost all of this is A.I.-driven.

Having spent my entire life trading stocks, I can confirm that, in recent years, the market's character has dramatically changed, and not for the better. Call it trading untouched by human hands.

Algorithms are trading against algorithms, and whoever wins the nuclear arms race brings home the big bucks.

Most of the time, that is Jim Simons' ***Renaissance Technologies***, the world's most successful hedge fund manager.

With armies of mathematicians and coders modifying sophisticated and secretive black boxes on a daily basis, their quantitative-based strategies make money almost every day of the year, and never carry a position overnight.

And you want to go up against that?

You used to need degrees in Finance and Economics, or perhaps an MBA to become a professional fund manager. Now it's a PhD in Computer Science.

Remember the May 2010 flash crash when the Dow Average plunged 1,100 points in minutes, wiping out \$4.1 billion in equity value? A.I.'s fingerprints were all over that.

Recently, the British pound lost 6% of its value in a mere two minutes, a move unprecedented in the history of foreign exchange markets. The culprit was A.I.

Don't expect the path forward to A.I. to be an easy one.

For a start, machines lack ethics, morals, and accountability. One U.S. local court hired an outside A.I. firm to provide sentencing guidelines for convicted criminals.

It didn't take long for an independent algorithm audit to show that the court's computer

discriminated against minorities, delivering far harsher sentences and probation limitations. That is illegal under the U.S. Constitution.

And you know that Tesla Model S-1 that is driving to New York?

What if it is placed in a situation where hitting one of two people is unavoidable? Which one will it choose to kill?

Indeed, the machines **already** have the power of life and death over all of us.

No less figures than Nobel Prize winner Dr. Stephen Hawking and Tesla's Elon Musk have warned that computers and the Internet may have the power to pose a threat to human existence within a decade.

They are especially concerned about the militarization of powerful robots, something I know the U.S. Defense Department is hell-bent on developing.

As I write this, the only thing preventing a drone attacking a village in Afghanistan is an army corporal hitting a red button on a console in Nevada.

In the future, antivirus software won't be needed to protect your computer. It will be essential to protect you **FROM** your computer.

You know that massive denial of service attack that hit the United States on October 21, 2016?

I asked one of my friends at security giant Palo Alto Networks (PANW) if it was the Russians again. He replied, "You better hope it's the Russians."

The implication is that the Internet may have launched the attack itself.

Now, about that stock recommendation.

Since we aren't venture capitalists we can't buy into pure A.I. firms in their early stages. And I'm too old to get a PhD in computer science.

We therefore have to be sneaky and get in through the back door via an indirect play, which still has plenty of upside leverage.

What is the one medium-sized, publicly listed company that most benefits from the A.I. explosion?

I have found exactly such a company (it was small a few years ago) that represents the marrying of the four biggest trends in technology today: A.I., self-driving cars, big data, and virtual reality.

That would be Nvidia (NVDA).

The Santa Clara, Calif.-based company manufactures graphics processing units (GPUs) for the gaming market as well as system on a chip units (SOCs).

It is heavily involved in supercomputing and mobile computing, producing processors for tablets, iPhones, and vehicle navigation systems.

Nvidia, named after the Greek god Nemesis, was the original supplier of processors for the Microsoft Xbox and Sony's (SNE) PlayStation 3.

In 2011, it demonstrated the first quad-core processor for mobile devices.

Nvidia has been on an acquisition tear over the past decade, picking up more than a dozen companies to expand its reach in the most advanced A.I. and manufacturing technologies, as well as picking up some first-class talent.

Nvidia has more engineers working on A.I. than any other company or institution in the world.

Its integrated stack of imaginative chip designs is unmatched.

Its principal competitors are Advanced Micro Devices (AMD), Intel (INTC) and Qualcomm (QCOM).

I spoke to Nvidia CEO Jen-Hsun "Jensen" Huang right after the company announced blockbuster second quarter results where sales rocketed by 110% year-on-year.

The Taiwan born, Stanford grad co-founded Nvidia in 1993. He bubbled with enthusiasm about the company's prospects.

He said that deep learning (A.I.) was progressing much faster than he imagined possible, where major firms use massive clusters of his company's GPUs.

A.I. will be the No. 1 driver of Nvidia's earnings going forward.

Huang also told me that self-driving cars will profoundly change society, and much sooner than you think.

The company has disruption written all over it.

Stock analysts have been stumbling over each other to upgrade the shares, with near-term upside targets of more than \$100 now commonplace. Hint: That's substantially higher than the recent close.

Sales of Nvidia's flagship product, the passively cooled 16GB Tesla P100 GPU, is being ravenously consumed by data centers around the country, and should grow by 95% during 2016, and another 50% in 2017.

Hold one of these dense, wicked-fast processors in your hand and you possess nothing less than the future of western civilization.

Over the long term, the picture looks even better. It should continue with annual earnings growth

of 20% to 30% a year for the foreseeable future.

At a minimum, the shares have at least another double in them, and perhaps another double after that as well.

To learn more about Nvidia, please visit its website [here](#).

Sounds like a peach of a long-term investment to me.

As for your computer, you better start leaving it unplugged at night. You never know.

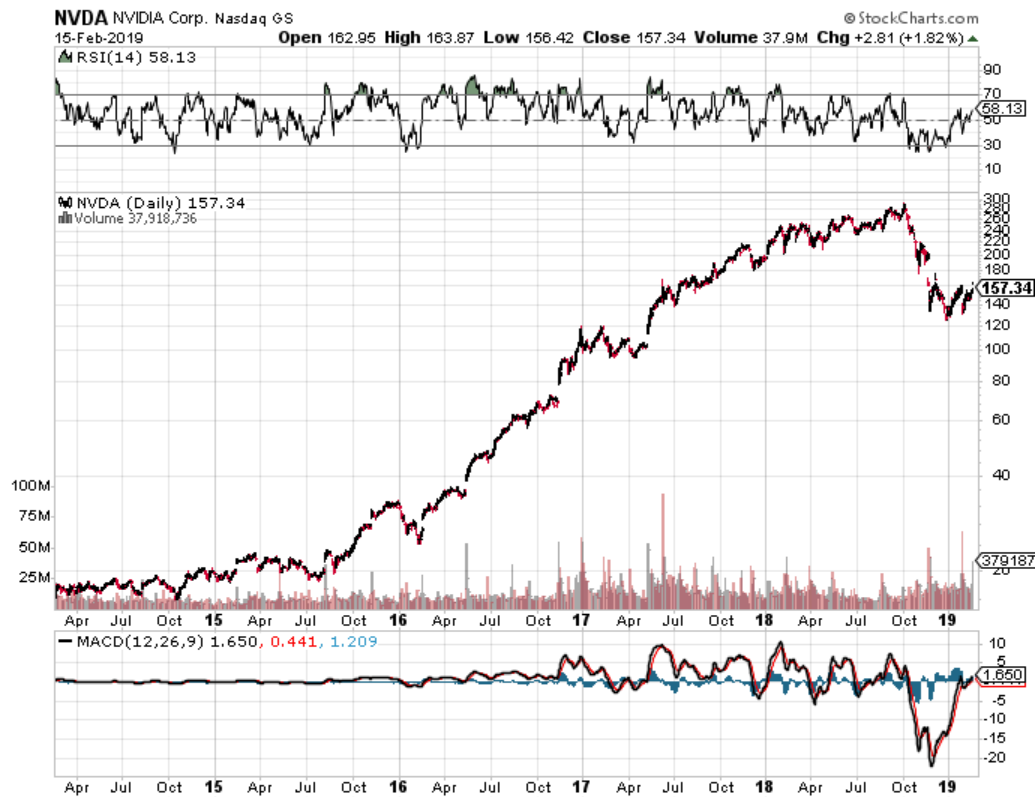

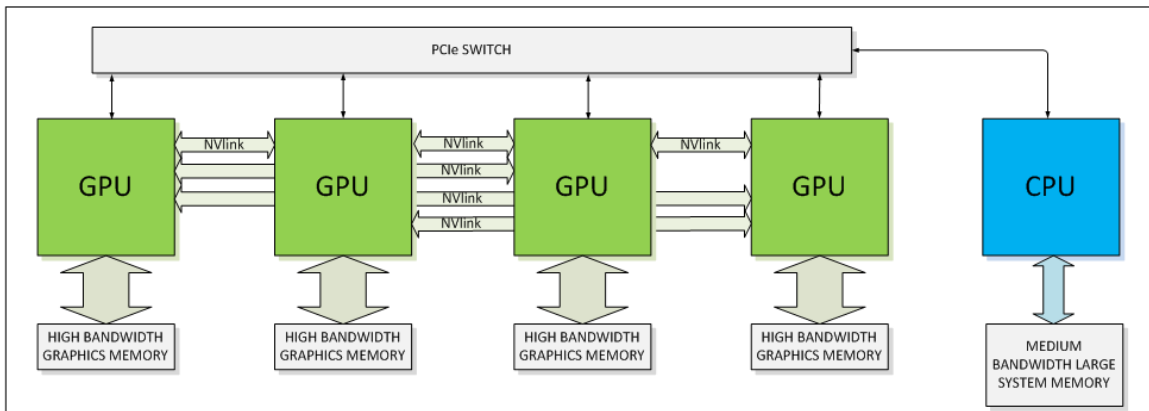
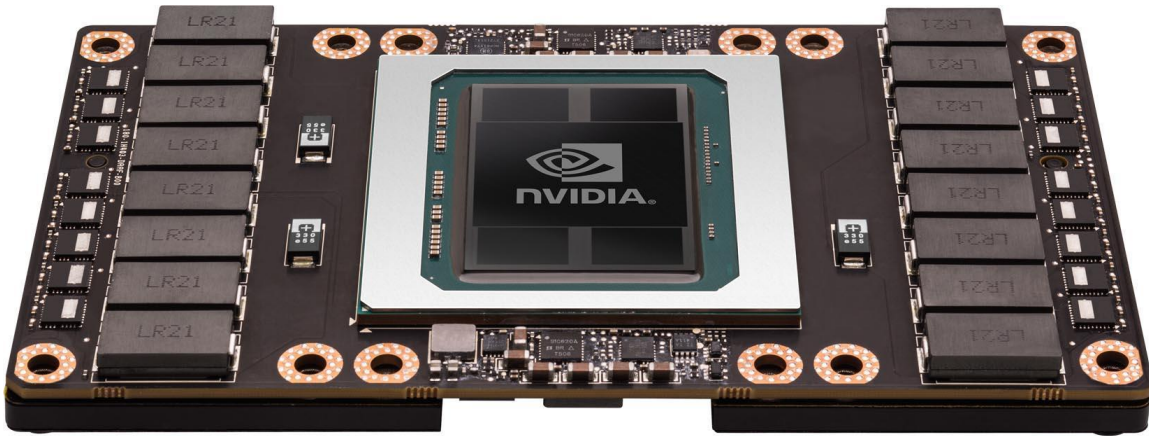



She's Smarter Than You Think

Click [HERE](#) to Learn more about Mad Hedge Fund Trader and the services we offer.

Why Energy Prices Are About to Collapse

What we are seeing now is nothing less than the complete remaking of the American energy supply.

It is a metamorphosis just as, if not more, dramatic than the initial electrification of the United States launched by Thomas Edison in 1876.

Think of it as a disruptive technology with a turbocharger.

Eventually, the cost of energy will drop to near zero in today's terms, possibly as soon as 2035. The consequences for your trading and investment portfolio will be tectonic.

This is what people don't get about solar.

Traditional forms of energy production and consumption, such as for oil, coal, natural gas, and hydroelectric, are subject only to linear improvements. Solar ones benefit from exponential growth.

There is, in effect, a solar Moore's law that sees efficiencies per dollar spent doubling every four years, such as we already have seen with the faster growth of microprocessor efficiencies since the 1960s. Exponential growth of efficiencies will bring exponential growth of profits.

I am old enough to have lived through several solar booms in the past, only to see them crash and burn.

In 1979, President Jimmy Carter installed panels on the White House roof to provide leadership during the Iran oil crisis, only to see them torn down by President Ronald Reagan three years later.

Solar is now growing far faster than any other power source in the U.S., some 50% a year for the past several years.

Annual installations of photovoltaic panels have soared from a token 0.3 gigawatts in 2000 to an impressive 7.286 gigawatts in 2015, more than enough to fuel 8.5 million American homes.

California alone now has over 500,000 homes running on solar. Installation trucks from a myriad of different local companies are seen everywhere.

This is all happening because of the simultaneous maturing and cross-pollination of technology, regulation, financing, and venture capital.

A key development was Chinese entry into mass production of solar panel which led to a near immediate 80% collapse in prices. They now control 70% of the global market.

But this also led to the bankruptcy of a large number of U.S. producers, including the ill-fated Solyndra, which I drive by every time I visit Tesla.

Chinese exports of panels to the U.S. are now subject to anti-dumping duties. This was all a windfall for the installation business.

Also helping has been the 90% collapse in the price of polysilicon, a key manufacturing component. Silicone (Si) is, in fact, one of the most common elements on the planet.

Still, the soft costs of sales, design, permitting, and labor account for two-thirds of a new installation today. By the way, solar has also proved to be a prolific new job creator. I can assure you, the cost of labor is never going to zero.

Some 15 years ago, I tried to install solar on my home and sell peak power to the grid. PG&E told me this was “illegal” because I would crash the grid, something I knew was patently false. This time around, my city permits sailed through effortlessly, and I received a polite email from PG&E instructing me how to read my new “net metering bill.” I wish renewing my driver’s license was so easy (that damn vision test).

For the first time in history, solar power is now cheaper than grid power on a non-subsidized basis. Costs are still set to fall dramatically from here. Fossil fuels are about to become, well, fossils.

The Paris, France-based International Energy Agency, no slouch when it comes to analyzing power data, predicts that solar will account for 27% of the global power supply by 2050, and will become the biggest single source.

But futurologist friends of mine, such as Tesla’s (TSLA) Elon Musk, Google’s head of engineering, Ray Kurzweil, and the late cosmologist Dr. Stephen Hawking, believe there is no reason why it shouldn’t be at 100% by 2030-2035. To quote Kurzweil, “We are only six more doublings away.”

Google (GOOG), by the way, is already one of the world’s largest generators and distributors of solar power, while Musk is the preeminent installer through his participation in SolarCity (SCTY).

Governments have been pouring fuel on the solar fire. Germany took an early lead installing a massive 35 gigawatts over the past decade. It has since decided to shutter its entire nuclear industry and offset its production with alternatives. But many of its subsidy programs were deep-sixed by the crash.

Former President Obama made a 30% investment tax credit a central plank of his 2009 supplementary budget which led to the current American solar renaissance.

That incentive expires in 2021 after getting a five-year extension in a rare bipartisan deal in Congress.

Former President Obama also upped the ante by using the Environmental Protection Agency to force power utilities to cut carbon emissions by 32% from 2005 levels. That involves setting a target of 28% alternative energy power generation by 2030.

The whole idea of using natural gas as a low carbon stepping stone has been abandoned. Hillary Clinton had previously weighed in with her own plans to shift the country from a carbon to a solar energy-based economy, if elected president.

She wanted nothing less than to eliminate all oil and gas subsidies worth \$100's of billions, and shift the money to alternatives.

That is a radical move. Her goal is to increase the solar share of American power generation to 33% by 2027.

Individual states have weighed in with their own measures. California has mandated that its residents obtain 30% of their power from alternatives by 2020.

More than two dozen other states have followed with similar measures, including several red ones. Solar is starting to transcend the political spectrum; the numbers are so compelling.

This isn't just a U.S. phenomenon, but a global one. Saudi Arabia has two of the world's largest solar plants on the drawing board to produce some 2 megawatts.

After all, why burn \$5 oil when you can sell it to foreigners (mostly the Chinese) at an extravagant \$50 a barrel. They also are major investors in the San Francisco alternative energy scene.

China is building far and away the biggest solar infrastructure and wants to build 70 gigawatts over the next two years.

Japan has a 20% solar target, thanks to the Fukushima nuclear disaster. India plans to provide cheap electricity via solar to 100,000 villages for the first time.

Improving solar cell efficiencies promises to take us further and faster into this brave new world.

My own SunPower (SPWR) X-335 panels, with their patented Maxeon solar cells, convert 20.3% of the sunlight they receive into electricity - the highest in the industry. Cheap imported Chinese panels offer efficiencies as low as 16% and don't last nearly as long. University labs have perfected cells with 45% efficiencies using advanced silicon compounds. I happen to know that the military has a 65% efficient cell. All that remains are the economies of mass production to bring them to the public market.

This is crucial for the solarization of the global economy. Every 1% improvement in efficiencies cuts that total cost of a newly installed system by 5%.

With the trends already in place, it is safe to assume that solar energy costs will fall by at least 10% a year for the foreseeable future. First Solar (FSLR), which specializes in large-scale, thin film, industrial facilities, expects solar costs to plunge from 63 cents per kilowatt in 2014 to only 40 cents by 2017.

Storage is another key part of the equation, as panels alone can only produce electricity during daylight. The cost of home storage batteries, which are charged by day and can run a home at night, have dropped by 70% over the past five years.

They dropped 70% when SolarCity completed its Nevada Gigafactory in 2018. That doubled the planet's lithium ion battery capacity in one shot. A second plant is planned.

For a more detailed explanation of that technology and the investment opportunities therein, please [click here](#) for ***Solar Energy's Missing Link***.

What are the investment implications of all this? Clearly, all of the companies mentioned in this piece are about to see their market size increase 30-fold.

But, what about everyone else?

The elimination of energy as a cost has enormous consequences for all companies. You can start with the energy-intensive ones in transportation, steel, and aluminum, and work your way down the list.

The profitability and efficiency of the entire economy will take a great leap forward, much like we saw with the mass industrialization that was first made possible by electricity during the 1920s. Share prices of all kinds will go ballistic.

Dow 200,000 anyone?

Since energy costs will eventually fall effectively to zero, that wipes out the present business model of the entire electric power industry. It will be the same as trying to sell something that is free, such as air.

That will force them to morph from energy producers to power distributors. Watch this space for a future piece on this issue.

So when readers ask me for the names of shares of companies that have the potential to rise tenfold in 10 years, this is one industry I always steer them toward.

To save yourself months of research on how to install your own solar system, please [click here](#) for ***How to Buy a Solar System***.

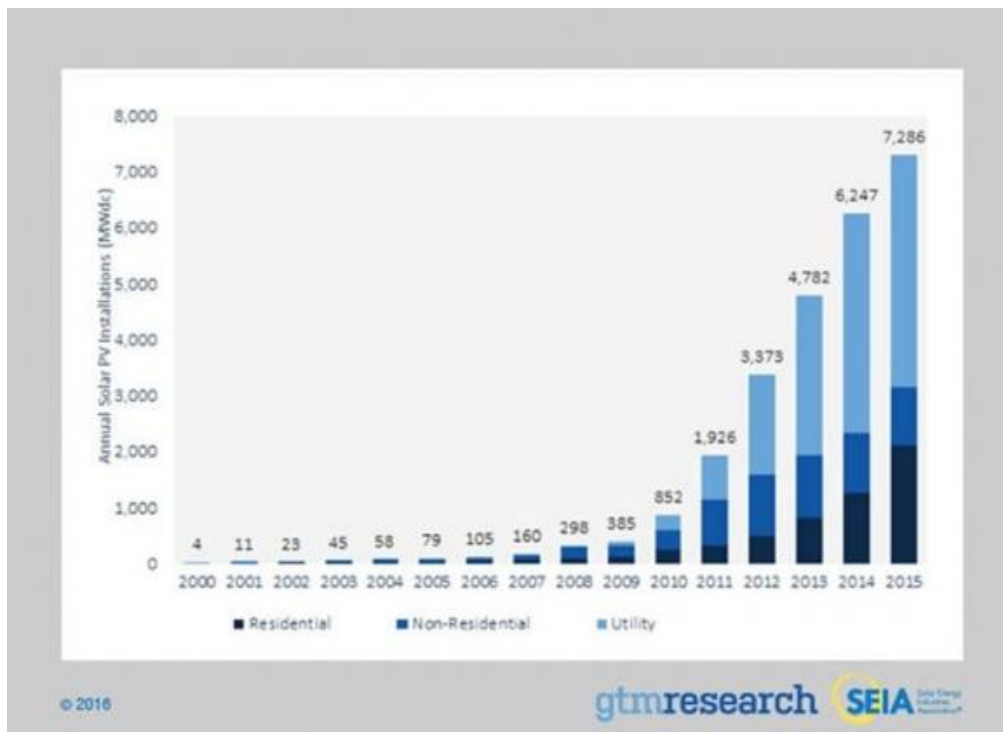

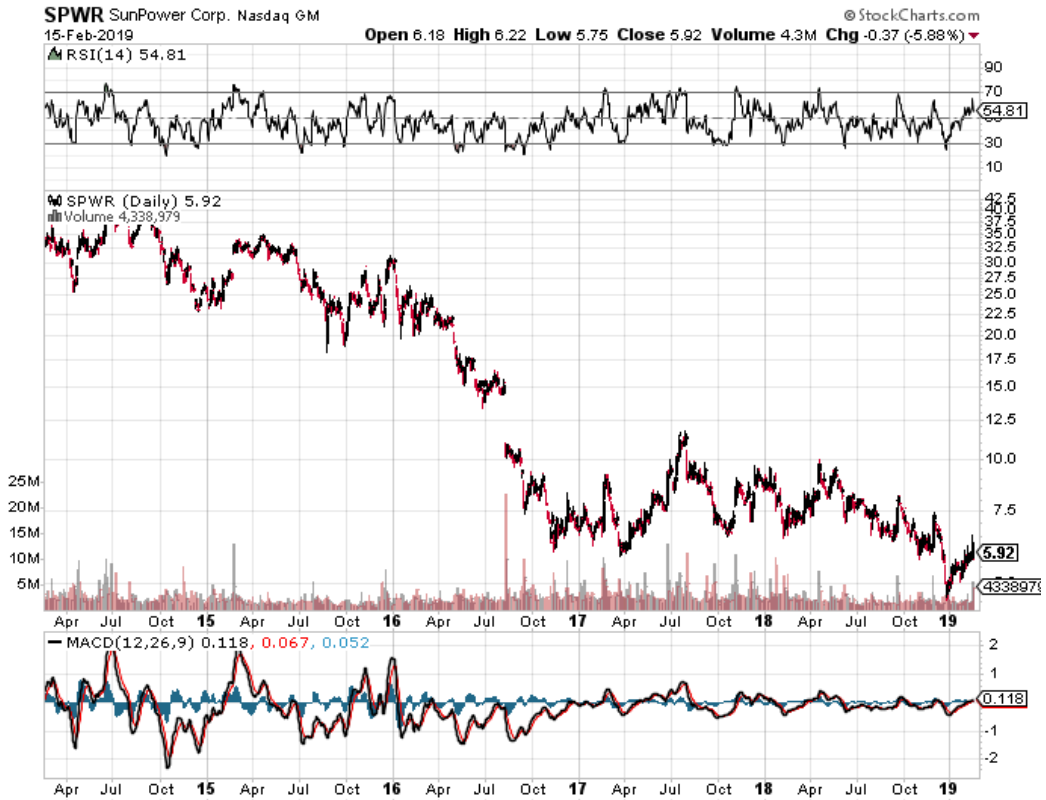

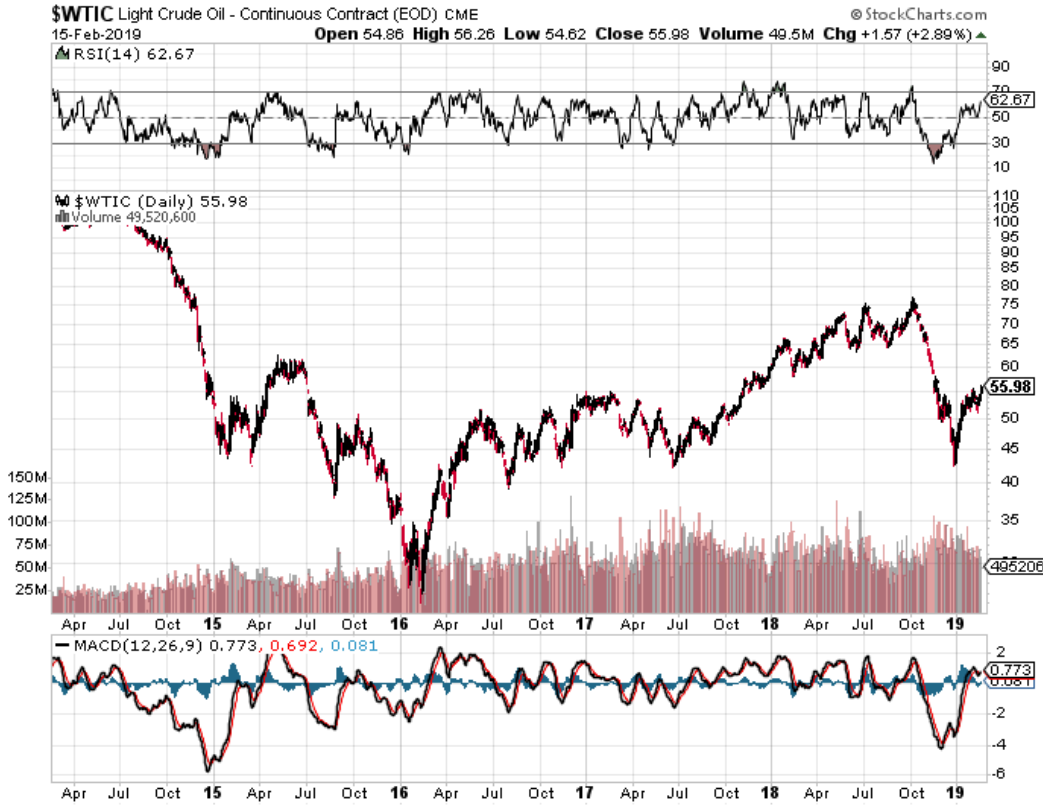



Joining the Brave New World

Click [HERE](#) to Learn more about Mad Hedge Fund Trader and the services we offer.

Revolutionary New Discovery Converts CO₂ into Alcohol

The Internet has recently been abuzz about a revolutionary new discovery that converts carbon dioxide (CO₂) into ethanol.

Readers often refer me to new, incredible, and earth-shaking technologies, which often turn out to be nothing more than investment scams. The cold fusion boom of the 1990s comes to mind.

As a reformed and non-practicing biochemist I decided to check this one out.

What I discovered blew my mind.

Scientists at the U.S. Department of Energy's Oak Ridge National Laboratory literally stumbled across a process that could become a game changer for the entire energy industry.

Carbon dioxide is passed over a carbon and copper catalyst, energized with a jolt of electricity, and ethanol comes out the other end. How nice is that!

Ethanol (CH₃CH₂OH) is the kind of alcohol we drink, and is found in beer, wine, and spirits. It is not to be confused with methanol (CH₃OH), known as rubbing alcohol, which is lethal if drunk in quantities.

Ethanol boils at 78.4 degrees centigrade, compared to 64.7 degrees for methanol, which is how home distillers and moonshiners keep from killing themselves.

Oak Ridge National Laboratory is no slouch when it comes to energy research.

Built in Tennessee in a huge rush during 1942, it used to be one of the most secretive research institutions in the world.

Its original mission was to produce highly enriched uranium for the first atomic bomb, known as the Manhattan Project. Many of my college professors worked there during WWII.

In recent years, it has broadened its mandate to include materials science, artificial intelligence, systems biology, and national security. It possesses the Titan, one of the world's most powerful supercomputers.

Since former President Obama came into office, it has received an infusion of cash to explore new forms of alternative energy.

To visit its website, please [click here](#).

The key to its method is how the copper is arranged. First, the researchers create a scaffold made from carbon and nitrogen. The surface is covered in tiny spikes, each about 50 nanometers high.

The researchers then deposit copper particles onto the surface, which acts as a catalyst for the reaction.

When electricity is run through the material, the reactions are concentrated at the very tips of the spikes, providing the energy required for carbon dioxide dissolved in water to break apart and reform as ethanol.

The reaction achieved an efficiency of 63 percent, using a power supply of just 1.2 volts at room temperature.

Of course, the process is still years away from scalability and mass production.

But the fact that this process can take place at room temperature and requires only small power inputs means it could become economically viable.

The long-term possibilities of this new technology would be momentous.

Previous carbon capture and conversion plans were wildly expensive. Carbon dioxide is one of the most stable molecules in the universe. Until now, breaking it apart required huge amounts of energy.

That is why the end products of all combustion are CO₂ and H₂O. There is nowhere else for a chemical reaction to go without help.

It would cost more than \$1 trillion just to convert America's existing coal-fired power plants (click here for "***The Price Tag for Clean Coal***" by [clicking here](#).)

This new technology could capture the carbon dioxide emitted by power plants, convert it into ethanol, and then burn the ethanol, all in a closed system. Nothing would reach the atmosphere.

Solar cells could be used to produce the ethanol during the day which is then burned at night.

Ethanol could also be used to power cars. In most states about 10% of the gasoline you purchase at the pump is comprised of ethanol.

The new process could extend a lifeline to the beleaguered coal industry (KOL), which has been in free fall for years.

Many of the biggest firms, such as Peabody Energy, Arch Coal, Alpha Natural Resources, and Walter Energy, have gone bankrupt. It is unlikely that another coal-fired power plant will ever be built in the U.S. again.

About 70% of America's coal output is now exported to China, much of it in rail cars rumbling past my home late at night.

Coal's problems have become so severe that the plight of unemployed coal miners has become an issue in the presidential election.

The big loser from this technological breakthrough (there is **ALWAYS** a big loser) is a farmer in the Midwest who grows corn (CORN).

About 40% of the total U.S. corn production is now used to make ethanol for fuel, an activity heavily subsidized by the government (for more on that sensitive topic, please [click here](#) for "***The Great Ethanol Boondoggle.***")

If the carbon dioxide conversion process goes mainstream, which could happen sooner than you think, it could trigger a collapse in corn prices, by half or more.

Maybe that is what the price of corn has been trying to tell us. For a host of reasons, it has been one of the world's worst-performing asset classes for the past four years.

Mind you, converting carbon dioxide to ethanol is no panacea. Burning ethanol puts plenty of CO₂ into the atmosphere as well, just not as much as gasoline. It is an improvement, but not a solution.

Sometimes, markets can sniff these things out sooner than we mere humans can. And I can tell you that my nose in particular is finely attuned to the scent of alcohol.

Should Jack Daniels be worried?

To read the full paper describing the carbon dioxide-ethanol process, please [click here](#).

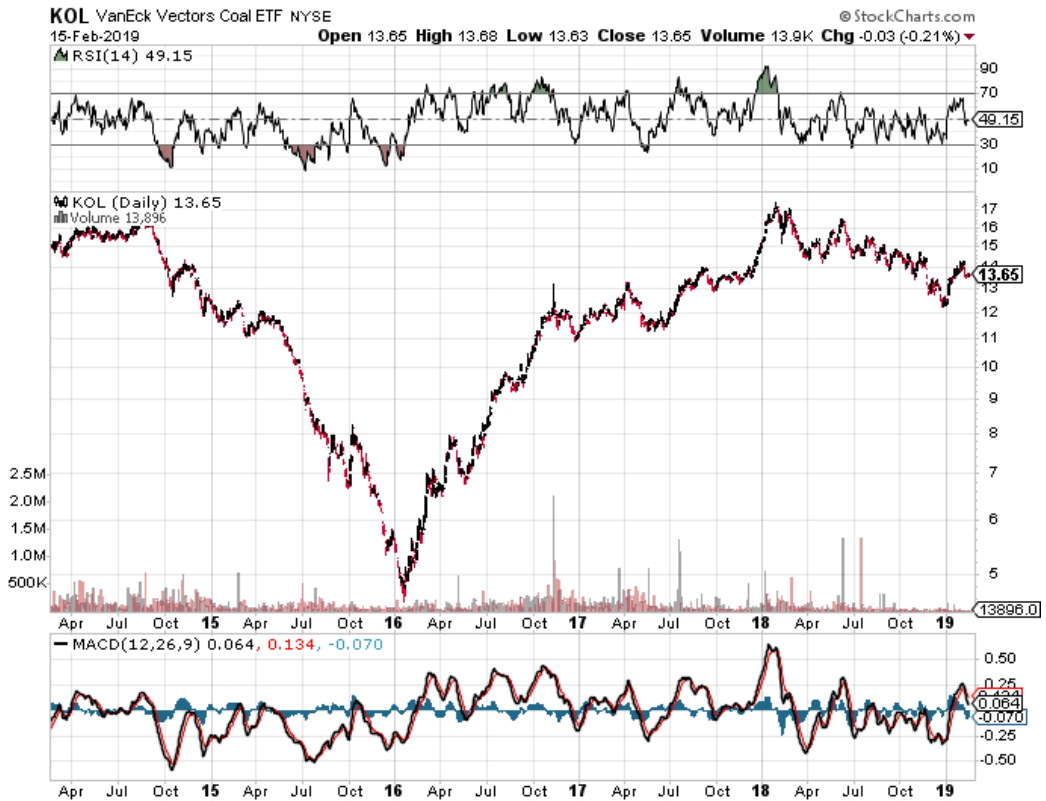
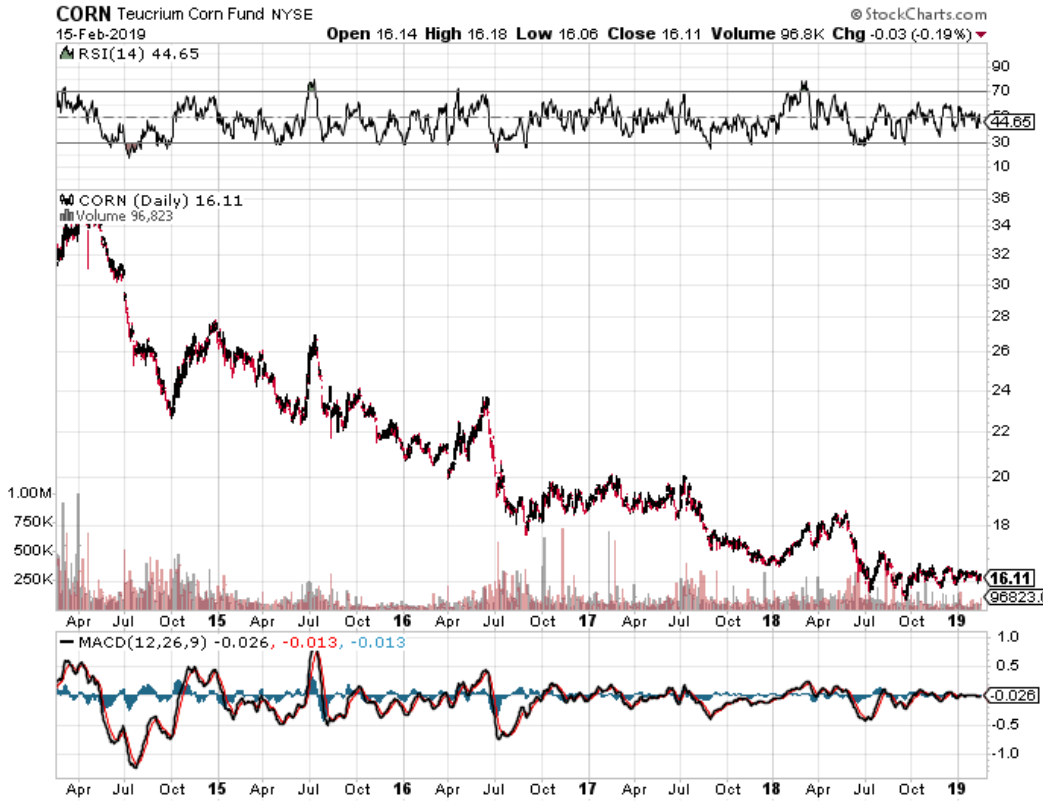

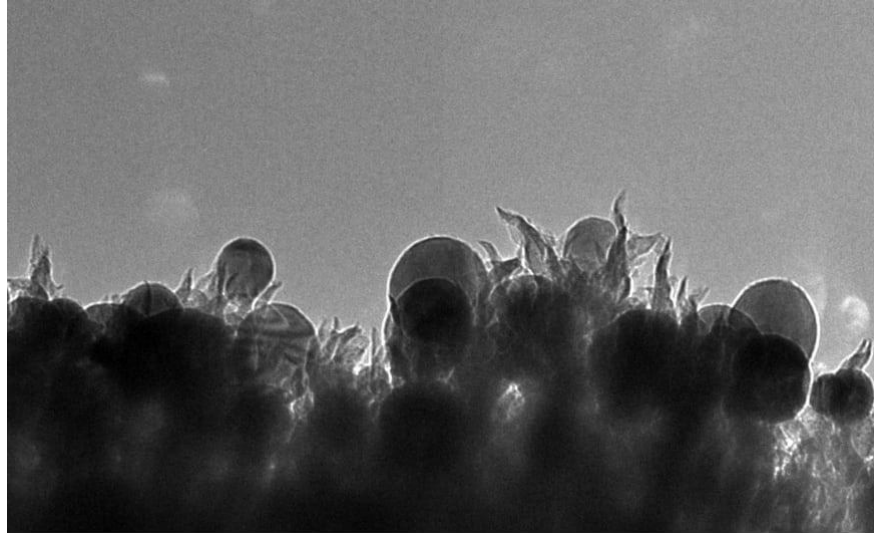

A Carbon Nanospike

Click [HERE](#) to Learn more about Mad Hedge Fund Trader and the services we offer.

Industries You Will Never Hear About From Me

The focus of this letter is to show people how to make money through investing in fast growing, highly profitable companies which have stiff, long-term macroeconomic winds at their backs.

That means I ignore a large part of the US economy, possibly as much as 75%, whose time has passed and are headed for the dustbin of history.

According to the Department of Labor's Bureau of Labor Statistics, the seven industries listed below are least likely to generate positive job growth in the next decade.

As most of these stocks are already bombed out, it is way too late to short them. As an investor, you should consider this a "no go" list. I have added my comments, not all of which should be taken seriously.

1) **Realtors** - The number of realtors is only down 10% from its 1.3 million peak in 2006. I have always been amazed at how realtors who add so little in value take home so much in fees, still around 6% of the gross sales price. Someone is going to figure out how to break this monopoly.

2) **Newspapers** - these probably won't exist in five years, as five decades of hurtling technological advances have already shrunk the labor force by 90%. Go online, or go away.

3) **Airline employees** - This is your worst nightmare of an industry, as management has no idea what interest rates, fuel costs, or the economy will do, which are the largest inputs into their business. Pilots will eventually work for minimum wage just to keep their flight hours up.

4) **Big telecom** - Can you hear me now? Nobody uses landlines anymore, leaving these companies with giant rusting networks that are costly to maintain. Since cell phone market penetration is 90%, survivors are slugging it out through price competition, cost cutting, and all that annoying advertising.

5) **State and Local Government** - With employment still at levels private industry hasn't seen since the seventies, firing state and municipal workers will be the principal method of balancing ailing budgets. Expect class sizes to soar to 80 or go entirely online, have to put out your own damn fires, and keep the 9mm loaded and the back door booby trapped for home protection.

6) **Installation, Maintenance, and Repair** - I have explained to my mechanic that the motor in my new electric car has only eleven moving parts, compared to 1,500 in my old clunker, and this won't be good for business. But he just doesn't get it. The winding down of our wars in the Middle East is about to dump a million more applicants into this sector. The last refuge of the trained blue-collar worker is about to get cleaned out.

7) **Bank Tellers** - Since the ATM made its debut in 1968, this profession has been on a long downhill slide. Banks have lost so much money in the financial crisis, they can't afford to hire humans any more. It hasn't helped that hundreds of banks have closed during the recession, with many survivors merging to cut costs (read fire more people). Your next bank teller may be a Terminator.



Out With the Old



And in With the New

Click [HERE](#) to Learn more about Mad Hedge Fund Trader and the services we offer.

Why Globalization Works

I am writing to you from the Virgin Atlantic First Class lounge at London's Heathrow Airport. I am awaiting my flight back to San Francisco after spending two months based in Dubrovnik, Croatia and Zermatt, Switzerland.

The good news here is that there is no longer a line to get a foot massage. The bad news is that they are no longer free, costing £35 for 30 minutes of destressing leisure.

Call it another perfect example of supply/demand elasticity. Nobody wants them when they are expensive.

I wish I could have walked down the main street of Dubrovnik with Donald Trump, who back then was campaigning for president on an anti-globalization platform.

Having been a vociferous supporter of globalization since its dawn, first during a decade spent as a reporter for *The Economist* magazine, and then as an investor, I could have explained how our international trading system works, and especially why it works for us.

There was a polyglot of travelers from all over the world.

Large groups of Chinese people were led by flag-bearing guides. Italian Millennials mobbed the bars at night. English couples strolled the majestic limestone fortress walls soaking up the sunshine. There was even the occasional American student backpacker repeating my own adventure from the 1960s.

And you know what? This disparate international group shared many things in common. Most of them spent much of the day glued to iPhones or Androids run by U.S.-designed apps. Many were staying in accommodations organized by Airbnb (there were more than 200 listings for the immediate Dubrovnik area).

They may have made the trip from the airport in an Uber cab. They wore Levi Strauss blue jeans. American pop music pulsed through their ear buds. Probably half of them arrived on a Boeing jet financed by the U.S. Export Import Bank.

In short, they were all sending enormous amounts of money to U.S. companies and shareholders in more ways than they could possibly count without even realizing it.

You never used to see tourists from most countries such as Russia, Spain, Portugal, Italy, or Ireland.

They were too poor.

Rapidly rising standards of living created by globalization changed all of that, creating an enormous new market for American products, especially technology ones.

My Airbnb neighbors in Dubrovnik included a family from Malaysia and a young couple from South Korea.

You can see some of this impact in international balance of trade statistics. In 2015, the U.S. ran a trade deficit with the world of \$500.3 billion with consumer electronics, oil, clothes, and cars as our largest imports.

Subtract our \$262.2 billion surplus in services, which includes financial services, education, patents, and other intellectual property, and that brings our current account deficit down by more than half to only \$238.1 billion.

But that doesn't tell the whole story.

Trade data completely misses the enormous number of products and services that are now given away **FOR FREE** in exchange for the chance of earning some uncertain revenue at some future date.

Give up your name and email address, and you can obtain almost any kind of online service for nothing. And as far as I know, no government agency has any measurement of this parameter whatsoever.

Needless to say, the United States is far and away the leader in this immeasurable field. By the way, this might also be the reason why the published productivity data has been so poor despite the fact that U.S. GDP has grown by 20% since 2009. Everywhere I look productivity is skyrocketing, including my own.

It also might be the reason why Amazon continuously sports a nosebleed valuation. Much of what it provides is **FREE** and therefore immeasurable.

Of course, globalization wrought havoc on your life if you went into it with the wrong job in the wrong industry and an inadequate skill set.

Blue collar workers tied to textiles, shoes, toys, and other low value-added manufacturing were toast, as their jobs fled offshore.

If you didn't retrain or adapt you became an angry, mostly white man.

As my friend, *New York Times* columnist Tom Friedman, likes to say, “Average doesn’t cut it anymore.”

However, while the jobs are gone, the bulk of the profits stayed here in the U.S. American companies offshored the \$2-an-hour jobs (mass assembly), but kept the \$100-an-hour ones (design and marketing) at home.

As my friends in the Chinese government never fail to point out, if they build the iPhone for \$100 and we sell it for \$700, we are the big winners, not them.

They believe we are perpetuating 19th century colonialism by making wage slaves of their workers.

They may be right.

Globalization enables the U.S. dollar to continue as the world’s reserve currency, as almost all international trade is conducted in the buck.

That is one of the greatest free lunches of all time. It enables the U.S. government to indirectly control the global economy through its own monetary policy. Some half of all U.S. government debt is owned by foreigners.

When sanctions forced Iran to drop out of the international trading system, what did it get? A Great Depression that cut its GDP by 25%. You can’t run a country of 80 million with oil barter deals, gold, and bitcoins alone.

There is also the huge defense benefits that globalization brings us.

Back in the early days, the main reason to steer a country into capitalism was to prevent it from going communist and therefore becoming an enemy.

Grow your allies and reduce your enemies, and your defense costs shrink dramatically, raising our standard of living.

That is what has happened.

Increased trade also boosted foreign standards of living, therefore, creating a growing market for American goods and services.

This was the whole point of the World Trade Organization, NAFTA, and the Trans-Pacific Partnership.

Humans rarely bite the hands that feed them. They are also highly unlikely to set fire to their paychecks or bomb their sources of income.

Make a foreigner a millionaire, and you turn him into a pacifist. I have seen this unfold time and time again over the past half century, be it in China, Russia, Vietnam, Cambodia, and most recently in Iran.

Create an embedded base of businessmen in any country who are getting rich off of you, and international relations invariably improve.

Any system based on greed is guaranteed to succeed.

A side benefit of all of this is that stock markets go up forever.

Since globalization started in earnest in 1951, the Dow Average has risen from \$239 to \$18,392, a prodigious gain of some 77-fold.

Wonder why?

Globalization is the mechanism through which America is paid the dividend for all of the good deeds it has done and inventions it has created for the past century. I am thinking about the construction of the Panama Canal, Lend Lease and the Marshall Plan, as well as the transistor, memory chip, microprocessor, personal computer, Windows, the Internet, online commerce, the iPhone, and social media.

That is why globalization is a win-win-win for everyone.

There are really only two true communist countries left in the world, Cuba and North Korea, which never joined the international trading community. They also happen to have the planet's lowest standards of living.

And Cuba will become totally capitalist within two years. Just give them a million iPhones, get them talking, and see what happens. Castro will become just another neighborhood in South San Francisco.

So why end a trading system from which America and its people have profited so mightily? That is a very good question, one that someone might ask Donald Trump.

To read more about America's massive services surplus in education, please [click here](#). To read more about my take on Tom Friedman's 50,000-foot view of the trends in the global economy, please [click here](#).

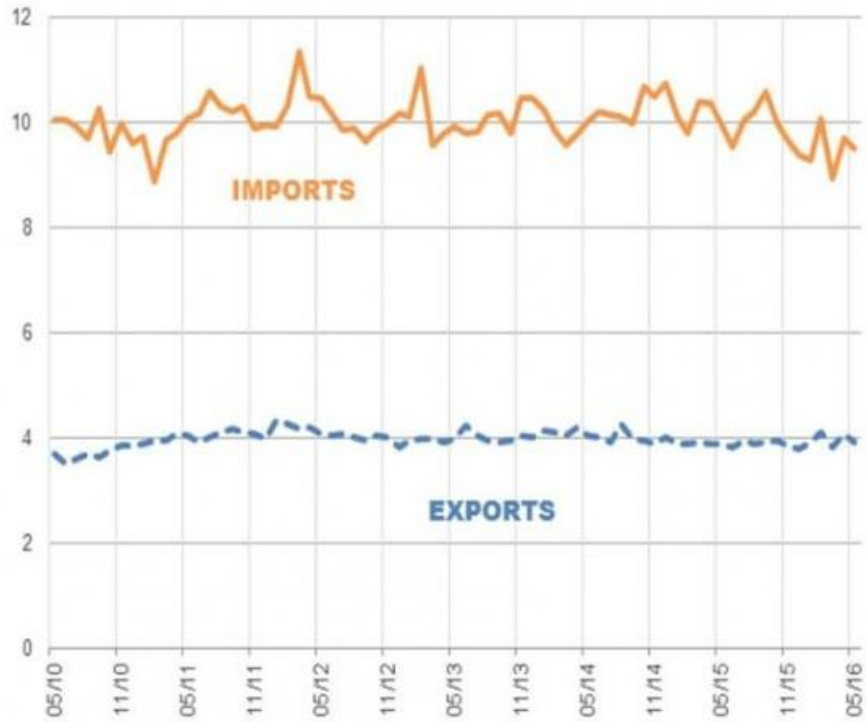

Click [HERE](#) to Learn more about Mad Hedge Fund Trader and the services we offer.

Will SpaceX Be Your Next Ten Bagger?

I am constantly on the lookout for ten baggers, stocks that have the potential to rise tenfold over the long term.

Look at the great long-term track records compiled by the most outstanding money managers. You'll see that they always have a handful of these that account for the bulk of their outperformance, or alpha, as it is known in the industry.

I've found another live one for you.

Elon Musk's SpaceX is so forcefully pushing forward rocket technology that he is setting up one of the great investment opportunities of the century.

In the past decade his start-up has accomplished more breakthroughs in advanced rocket technology than have been seen in the past half century, since the golden age of the Apollo space program.

As a result, we are now on the threshold of another great leap forward into space. Musk's ultimate goal is to make mankind an "interplanetary species."

There is only one catch.

SpaceX is not yet a public company, being owned by a handful of fortunate insiders and venture capital firms. But you should get a shot at the brass ring someday.

The rocket launch and satellite industry is the biggest business of which you have never heard, accounting for \$200 billion a year in sales globally. This is probably because there are no pure stock market plays.

Only two major companies are public, Boeing (BA) and Lockheed Martin (LMT), and their rocket businesses are overwhelmed by other aerospace lines.

The high value-added product here is satellite design and construction, with rocket launches completing the job.

Once dominated by the U.S., the market for launches has long since been ceded to foreign competitors. The business is now captured by Europe (the Ariane 5), China (the Long March 5), and Russia (the Angara A5).

Until recently, American rocket makers were unable to compete because decades of generous government contracts enabled costs to spiral wildly out of control.

Whenever I move from the private to the governmental sphere, I am always horrified by the gross indifference to costs. This is the world of the \$10,000 coffee maker and the \$20,000 toilet seat.

Until 2010, there was only a single U.S. company building rockets, the United Launch Alliance (ULA), a joint venture of Boeing and Lockheed Martin. ULA builds the aging Delta IV and Atlas V rockets.

The vehicles are launched from Cape Canaveral, Florida and Vandenberg Air Force Base in California, one of which I had the privilege to witness. They look like huge roman candles that just keep on going, until they disappear into the blackness of space.

Enter SpaceX.

Extreme entrepreneur Elon Musk has shown a keen interest in space travel throughout his life. The sale of his interest in PayPal, his invention, to Ebay (EBAY) in 2002 for \$165 million, gave him the means to do something about it.

He then discovered Tom Mueller, a childhood rocket genius from remote Idaho who built the largest ever amateur liquid fueled vehicle, with 13,000 pounds of thrust. Musk teamed up with Mueller to found SpaceX in 2002.

A decade of grinding hard work, bold experimentation, and heartrending testing ensued, made vastly more difficult by the 2008 Great Recession.

SpaceX's **Falcon 9** first flew in June 2010, and successfully orbited earth. In December 2010 it launched the **Dragon** space capsule and recovered it at sea. It was the first private company ever to accomplish this feat.

Dragon successfully docked with the International Space Station (ISS) in May 2012. NASA has since provided \$440 million to SpaceX for further **Dragon** development.

The result was the launch of the **Dragon V2** (no doubt another historical reference) in May 2014, large enough to carry seven astronauts.

SpaceX conducted the first successful flight test of the new **Dragon** capsule on May 6 of last year.

Then, Musk really upped his game by successfully pulling off the first-ever landing of a booster rocket on a platform at sea in April, 2016. This is crucial for his plan to dramatically cutting the cost of space travel.

Commit all these names to memory. You are going to hear a lot about them.

Musk's spectacular success with SpaceX can be traced to several different innovations.

He has taken the Silicon Valley hyper-competitive ethos and financial model and applied it to the aerospace industry, the home of the bloated bureaucracy, the no-bid contract, and the agonizingly long time frame.

For example, his initial avionics budget for the early **Falcon 1** rocket was \$10,000, and was spent on off-the-shelf consumer electronics. It turns out that their quality had improved so much in recent years they met military standards.

But no one ever bothered to test them. The \$10,000 wouldn't have covered the food at the design meetings at Boeing or Lockheed Martin, which would have stretched over years. Similarly, Musk sent out the specs for a third-party valve actuator no more complicated than a garage door opener, and a \$120,000 one-year bid came back. He ended up building it in-house for \$3,000. Musk now tries to build as many parts in-house as possible, giving it additional design and competitive advantages.

This tightwad, full-speed-ahead and damn-the-torpedoes philosophy overrides every part that goes into SpaceX rockets.

Amazingly, the company is using 3D printers to make rocket parts, instead of having each one custom-made.

Machines guided by computers carve rocket engines out of a single block of inconel nickel-chromium superalloy, foregoing the need for conventional welding, a frequent cause of engine failures.

SpaceX is using every launch to simultaneously test dozens of new parts on every flight, a huge cost saver that involves extra risks that NASA would never take. It also uses parts that are interchangeable on all its rocket types, another substantial cost saver.

SpaceX has effectively combined three nine-engine **Falcon 9** rockets to create the 27 engine **Falcon Heavy**, the world's largest operational rocket. It has a load capacity of a staggering 53 metric tons, the same as a fully loaded Boeing 737. It has half the thrust of the gargantuan Saturn V moon rocket that last flew in 1973.

Musk is able to capture synergies among his three companies not available to any competitor. SpaceX gets the manufacturing efficiencies of a mass production carmaker. Tesla Motors has access to the futuristic space age technology of a rocket maker. Solar City (SCTY) provides cheap solar energy to all of the above.

Herein lies the play.

As a result of all these efforts, SpaceX today can deliver what ULA does for 76% less money with vastly superior technology and capability. Specifically, its **Falcon Heavy** can deliver a 116,600-pound payload into low earth orbit for only \$90 million, compared to the \$380 million price tag for a ULA Delta IV 57, 156 pound launch.

In other words, SpaceX can deliver cargo to space for \$772 a pound, compared to the \$7,515 a pound UAL charges the U.S. government. That's a hell of a price advantage.

You would wonder when the free enterprise system is going to kick in and why SpaceX doesn't already own this market.

But selling rockets is not the same as shifting iPhones, laptops, watches, or cars. There is a large overlap with the national defense of every country involved.

Many of the satellite launches are military in nature and top secret. As the cargoes are so valuable, costing tens of millions of dollars each, reliability and long track records are big issues.

Enter the wonderful world of Washington D.C. politics. UAL constructs its Delta IV rocket in Decatur, Alabama, the home state of Senator Richard Shelby.

The first Delta rocket was launched in 1960, and much of its original ancient designs persist in the modern variants. It is a major job creator in the state.

Shelby has criticized former President Obama's attempt to privatize and modernize the rocket business as "a faith-based initiative." ULA is a major contributor to Shelby's campaigns.

ULA has no rocket engine of its own. Therefore, it buys engines from Russia, complete with blueprints, hardly a reliable supplier. Magically, the engines have so far been exempted from the economic and trade sanctions enforced by the U.S. against Russia for its invasion of the Ukraine.

ULA has since signed a contract with Amazon's Jeff Bezos-owned Blue Origin, which is also attempting to develop a private rocket business, but is miles behind SpaceX.

Musk testified in front of Congress in 2014 about the viability of SpaceX rockets as a financially attractive, cost-saving option. His goal is to break the ULA monopoly and get the U.S. government to buy American. You wouldn't think this is such a tough job, but it is.

Musk has since sued the U.S. Air Force to open up the bidding.

Elon became a U.S. citizen in 2002 primarily to qualify for bidding on government rocket contracts, addressing national security concerns.

NASA did hold open bidding to build a space capsule to ferry astronauts to the International Space Station. Boeing won a \$4.2 billion contract, while SpaceX received only \$2.6 billion, despite superior technology and a lower price.

It is all part of a 50-year plan that Musk confidently outlined to a venture capital friend of mine two decades ago. So far, everything has played out as predicted.

The Holy Grail for the space industry has long been the building of reusable rockets, thought by many industry veterans to be impossible.

Imagine what the economics of the airline business would be if you threw away the airplane after every flight? It would cost \$1 million for one person to fly from San Francisco to Los Angeles.

This is how the launch business has been conducted since the inception of the industry in the 1950s.

SpaceX is on the verge of accomplishing exactly that. It will do so by using its **SuperDraco** engines and thrusters to land rockets on a platform at sea. Then you just reload propellant and relaunch.

The concept has so far been successfully tested to an altitude of 1,000 meters ([Click link](#) for the YouTube video.)

Attempts to do this from a live launch had some setbacks ([Click here](#) for the first video where they almost made it and [click here](#) for the second), but it was successfully pulled off in December 2015 ([Click here for that video.](#))

Consequently, launch costs will plummet to pennies on the dollar. If SpaceX can chop payload costs to under \$100 compared to ULA's \$7,515, that is a savings that even Richard Shelby can't argue against.

Talk about disruptive innovation with a turbocharger!

The company is building its own spaceport in Brownsville, Texas, that will be able to launch multiple rockets **a day**.

The Hawthorne, Calif., factory (where I charge my own Tesla S-1 when in L.A.) now has the capacity to build 20 rockets a year. This will eventually be ramped up to hundreds.

SpaceX is the only organization that offers a launch price list on its website, much as Amazon sells its books (<http://www.spacex.com/about/capabilities>). The **Falcon 9** will carry 28,930 pounds of cargo into low earth orbit for only \$60.2 million. Sounds like a bargain to me.

SpaceX currently has over \$5 billion in contracts to fly more than 50 missions for a variety of private and governmental entities, making the company cash flow positive. This includes a \$1.6 billion NASA contract to supply the (ISS).

This no doubt includes an assortment of tax breaks which Musk has proved adept at harvesting. He has been a quick learner with the ways of Washington.

Customers have included the Thai telecommunications firm, Rupert Murdoch's Sky News Japan, an Israeli telecommunications group, and the U.S. Air Force.

So when do we mere mortals get to buy the stock? Musk estimates at 12 flights a year the company will earn a 10% return on capital, making it worth \$4 billion to \$5 billion.

The current exponential growth in broadband will lead to a similar growth in satellite orders, and therefore rocket launches. With that, the commercial future of the company looks especially bright.

However, Musk is in no rush to go public. A permanent, viable, and sustainable colony on Mars has always been a fundamental goal of SpaceX. It would be a huge distraction for a publicly managed company. That makes it a tough sell to investors in the public markets.

You can well imagine that the next recession would bring cries from shareholders for cost cutting that would put the Mars program at the top of any list of projects to go on the chopping block. So Musk prefers to wait until the Mars project is well established before entertaining an IPO.

Musk expects to launch a trip to Mars by 2025 and establish a colony that will eventually grow to 80,000. Tickets will be sold for \$500,000.

There are other considerations. Many employees and early venture capital investors wish to realize their gains and move on. Public ownership would also give the company extra ammunition for cutting through Washington red tape. These factors point to an IPO that is earlier than later.

On the other hand, Musk may not care. The last net worth estimate I saw for him was \$13 billion. If his three companies increase in value by 10 times over the next decade, as I expect, that would increase his wealth to \$130 billion, making him the richest person in the world.

If an IPO does come, investors should jump in with both boots. While the value of the firm may have already increased tenfold by then, there may be another tenfold gain to come. Get on the Elon Musk train before it leaves the station.

To describe Musk as a larger-than-life figure would be something of an understatement. Musk is the person on which the fictional playboy/industrialist/technology genius, Tony Stark, in the ***Iron Man*** movies has been based.

When the Disney movie, ***Tomorrowland***, was released last year, a Tesla supercharging station featured prominently. Musk takes all this in in good humor, lending a Tesla roadster to the film producers.

Musk has said he wishes to die on Mars, but not on impact. Perhaps it would be the ideal retirement for him, say around 2045, when he will be 75.

To visit the SpaceX website, please [click here](#). It offers very cool videos of rocket launches and a discussion with Elon Musk on the need for a Mars mission.



Catching a Dragon by the Tail



This Could Be the Stock Performance



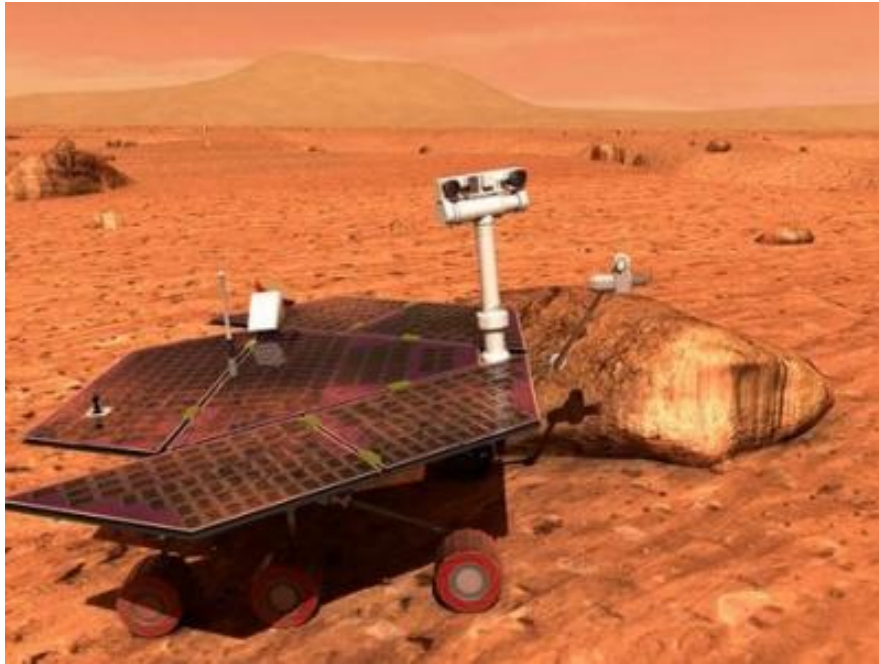

Is Mars the Next Hot Retirement Spot?



Click [HERE](#) to Learn more about Mad Hedge Fund Trader and the services we offer.

Is Airbnb Your Next Ten Bagger?

I was not surprised to hear that the home-sharing app, **Airbnb**, was given a \$30 billion valuation in the latest venture capital funding round.

The big question for you and me is: Will the valuation soar tenfold to \$300 billion, and how much of a piece of that will you and I be allowed to get?

To answer that question, I have recently spent six weeks traveling around Europe as an Airbnb customer. This enabled me to understand its business model, its strengths and weaknesses, and analyze its long-term potential.

As a customer, the value you receive is nothing less than amazing.

I have been a five-star hotel client for most of my life, with someone else picking up the tab much of the time, so I have a pretty good idea on the true value of accommodations.

What you get from Airbnb is nothing less than spectacular. You get three or four times the space for one-third the price.

The standards are often five-star and at the top end, depending on how much you spend. I found I could often get an entire three-bedroom house for the price of a single hotel room, with a better location.

Or, I could get an excellent abode in rural settings, where none other was to be had, whatsoever.

That's a big deal for someone like me who spends so much of the year on the road. You also get a new best friend in every city you visit.

On most occasions the host greeted me on the doorsteps with the keys, and then introduced me to the mysteries of European kitchen appliances, heating, and air-conditioning.

Pre-stocking the refrigerator with fresh milk, coffee, tea, and jam seems to be a tradition the hosts pick up in their Airbnb orientation course.

One in Waterford, Ireland, even left me a bottle of wine, plenty of beer, and a frozen pizza. She read my mind. Thanks, Mary!

They then took me on a one-hour tour of their city, divulging secrets about their favorite restaurants, city sights, and nightspots. Every one proved golden.

After you check out, Airbnb asks you to review the accommodation. These can be incredibly valuable in deciding your next pick.

I had one near miss with what I thought was a great deal in London, until I read, “The entire place reeks of Indian cooking.”

Similarly, the hosts rate you as a guest. One hostess shared a story about picking up her clients from town after they got drunk and lost in the middle of the night. Then they threw up in the back of the car on the way home.

Guests forgetting to return keys are another common complaint.

Needless to say, I received top ratings from my hosts, as fixing their Wi-Fi to boost performance became a regular habit of mine.

After my initial experience in London, I thought the experience might be a one-off, limited to only the largest cities. So I started researching accommodations for my upcoming trips.

I couldn't have been more wrong.

Just the Kona Coast on the big island of Hawaii had an incredible 50 offerings, including several bargain beachfront properties.

The center of Tokyo had more than 300 listings. The historic district in Florence, Italy, had an incredible 351 properties.

Fancy a retreat on the island of Bali in Indonesia and tune up your surfing? There are more than 197 places to stay!

While we weren't looking, Airbnb has truly gone global.

Airbnb's business model is almost too simple to be true, involving no more than a couple of popular applications. Call it an artful melding of Google Earth, email, text, and PayPal.

The company has over 2 million hosts worldwide, and 260 million guests worldwide. That supply/demand imbalance shifts the burden of cost to the renters, who usually have to fork out a 12% fee, plus the cost of the cleaning service.

Hosts only pay 3% to process the credit card fees for the payment.

The tidal wave of revenues this has created has enabled Airbnb to become San Francisco's second largest privately owned "unicorn," right after the \$65 billion behemoth ride-sharing app, Uber.

To say that Airbnb has created controversy would be a huge understatement.

For a start, it has emerged as a major challenge to the hotel industry, which is still stuck with a 20th century business model. There's no way hotels can compete on price.

One Airbnb "superhost" in Manhattan is managing 200 apartments, essentially creating from scratch a medium-sized virtual "hotel."

Taxes are another matter.

Some municipalities require hosts to pay levies of up to 20%, while others demand quarterly tax filings and withholding taxes. That is, if tax collectors can find them.

Airbnb may be the largest new source of tax evasion today.

In cities where housing is in short supply, Airbnb is seen as crowding out local residents. After all, an owner can make far more money subletting their residence nightly than with a long-term lease.

Several owners told me that Airbnb covered their entire housing cost for the year, while paying off the mortgage at the same time.

Owners in the toniest neighborhoods, like midtown Manhattan off of Central Park or the old city center in Dubrovnik, rent their homes out as much as 180 days a year.

Airbnb is nothing less than life changing.

That has forced local governments to clamp down.

San Francisco has severe, ironclad planning and zoning restrictions that only allow 2,000 new residences a year to come on the market.

It is cracking down on Airbnb, as well as other home sharing apps such as **FlipKey**, **VRBO**, and **HomeAway**, by forcing hosts to register with the city or face brutal \$1,000-a-day fines. So far, only 1,675 out of 9,000 hosts have done so.

Ratting out your neighbor as an off-the-grid Airbnb member has become a new cottage industry in the City by the Bay.

Airbnb is fighting back with multiple lawsuits, citing the federal Communications Decency Act, the Stored Communications Act, and the First Amendment covering the freedom of speech. It is a safe bet that a \$30 billion company can spend more on legal fees than a city the size of San Francisco.

The company has also become the largest contributor in San Francisco's local elections. In 2015, it fought a successful campaign against Proposition "F", meant to place severe restrictions on its services.

An Airbnb stay over is not without its problems.

The burden of truth in advertising is on the host, not the company, and inaccurate listings are withdrawn only after complaints.

A 20-something-year-old guy's idea of cleanliness may be a little lower than your own. Long-time users learn the unspoken "code."

"Cozy" can mean tiny, "as is" can be a dump, and "lively" can bring the drunken screaming of four letter words all night long, especially if you are staying upstairs from a pub.

And that spectacular seaside view might come with relentlessly whining Vespas on the highway out front. Always brings earplugs and a sleep mask as a precaution.

When researching complaints, it seems that the worst of the abuses occurs in shared accommodations. Learning new foreign cultures can be fascinating, but your new roommate may want to get to know you better than you want.

In one notorious incident a Madrid guest was raped. The best way to guard against such experiences is to rent the entire residence for your use only, as I do. Another problem arises when properties are rented out for illegal purposes, such as prostitution or drug dealing.

More than once, an unsuspecting resident woke up one morning to discover they were living next door to a new bordello.

Wild parties that trash the dwelling, annoy the neighbors, and bring in the police are another worry.

Of course, the million-dollar question is "When will the company go public?"

The current "unicorn" philosophy is to milk the company for all it's worth, and take it public when it is about to go ex-growth.

That's what happened to Twitter (TWTR), which grew exponentially, and then saw shares dive a gut-churning 72% after its initial public offering.

On seeing the massive crowds of new tourists packing Europe this summer, my conclusion is that the travel industry is entering a hyper-growth phase. Blame the emerging middle-class Chinese, who seem to be everywhere.

That means that at whatever price Airbnb goes public, there may not be a ten bagger left for you. But a two or three bagger may be possible.

The real shock came when I left Airbnb and stayed in a regular hotel. Include the fees and the cleaning charges, and the service is no longer competitive for a single-night stay.

In any case, most hosts have two- or three-night minimums to minimize hassle.

When I checked in at a Basel, Switzerland, five star hotel, all I got was a set of keys and a blank stare. No great restaurant tips, no local secrets, no new best friend.

I spent that night surfing www.airbnb.com, planning my next adventure.

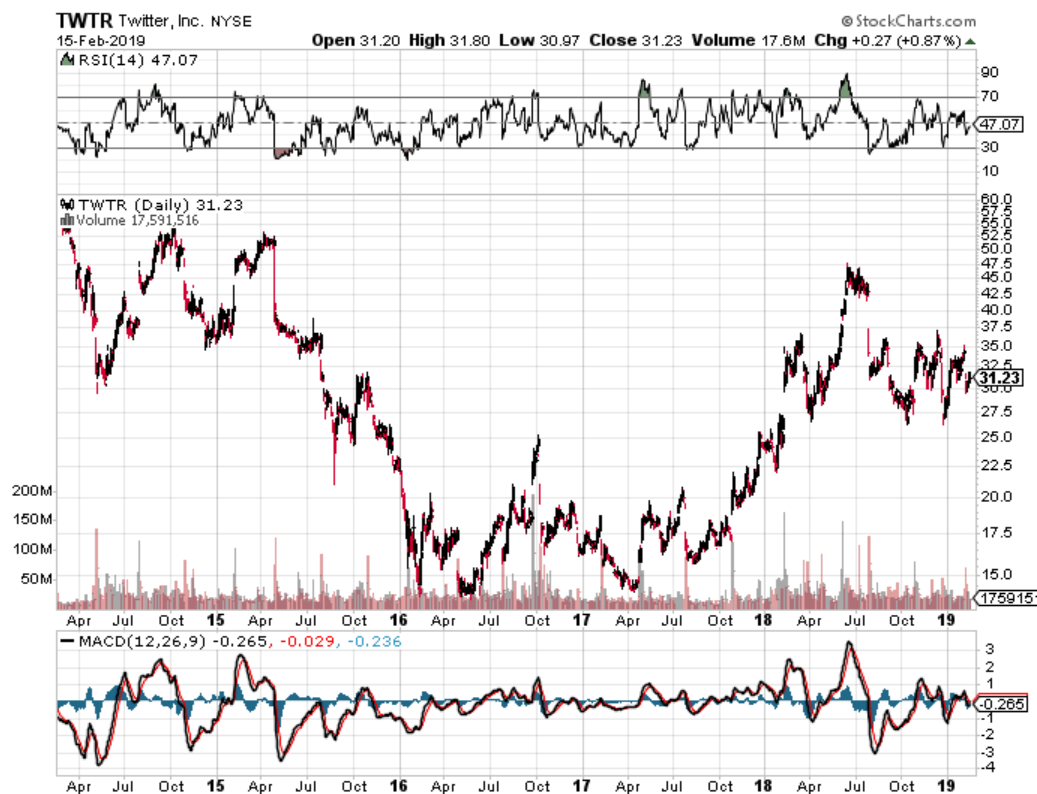

Is Airbnb the Next Ten Bagger or the Next Twitter?



Getting to Know My Dubrovnik Hostess

Click [HERE](#) to Learn more about Mad Hedge Fund Trader and the services we offer.

Why Water is One of 2019's Best Sectors

I bet you didn't know that water infrastructure plays have been one of the top-performing stock sectors since 2016. In fact, shares of this little known industry have been up substantially since the market bottom that year.

If you think that energy is scarce, it will pale in comparison to the next water crisis. So investment in fresh water infrastructure is going to be a great recurring long-term investment theme.

One theory about the endless wars in the Middle East since 1918 is that they have really been over water rights.

Although earth is often referred to as the water planet, only 2.5% is fresh, and three quarters of that is locked up in ice at the North and South Poles. Global warming is freeing up some of this, but not fast enough.

In places such as China, with a quarter of the world's population, up to 90% of the freshwater is already polluted, some irretrievably so, with heavy metals.

About 18% of the world population lacks access to potable water, and demand is expected to rise by 40% in the next 20 years.

Aquifers in the U.S., which took nature millennia to create, are approaching exhaustion.

It has become so extreme in California, that subsidence has destroyed hundreds of buildings. The Golden State's Central Valley is now about 10 feet lower than it was during the 19th century. While membrane osmosis technologies exist to convert seawater into fresh, they use 10 times more energy than current treatment processes, a real problem if you don't have any, and will easily double the end cost of water to consumers.

While it may take 16 pounds of grain to produce a pound of beef, ***it takes a staggering 2,416 gallons of water*** to do the same. Beef exports are really a way of shipping water abroad in concentrated form.

The United Nations says that \$11 billion a year is needed for water infrastructure investment, and \$15 billion of the 2008 U.S. stimulus package was similarly spent.

It says a lot, that when I went to the University of California at Berkeley School of Engineering to research this piece, most of the experts in the field had already been retained by major hedge funds and were not allowed to talk!

At the top of the shopping list to participate here should be the Claymore S&P Global Water Index ETF (CGW). You can get it for a bargain now, as it has just fallen by more than 10% since the stock market meltdown began.

You can also visit the PowerShares Water Resource Portfolio (PHO), the First Trust ISE Water Index Fund (FIW), or the individual stocks Veolia Environment (VE) VEOEY?, Tetra Tech (TTEK), and Pentair (PNR).

Who has the world's greatest *per capita* water resources? Siberia, which could become a major exporter of H₂O to China in the decades to come.

There is a potential happy ending to this story. If solar energy cost improvements continue their Moore's law-like descent, energy will effectively become free by the 2030s.

If you think this is pie-in-the-sky stuff, know this: On peak days, alternatives are now accounting for 56% of California power grid, largely through solar.

That will dramatically drop the cost of desalination. Indeed, major efforts along these lines are already underway by utilities in the Middle East.

San Diego's Poseidon project only recently came online, and is producing 50 million gallons of fresh water a day. The goal is for the Carlsbad facility to obtain 8% of the county's water from the ocean by 2020.

The last time I checked, we had plenty of seawater.

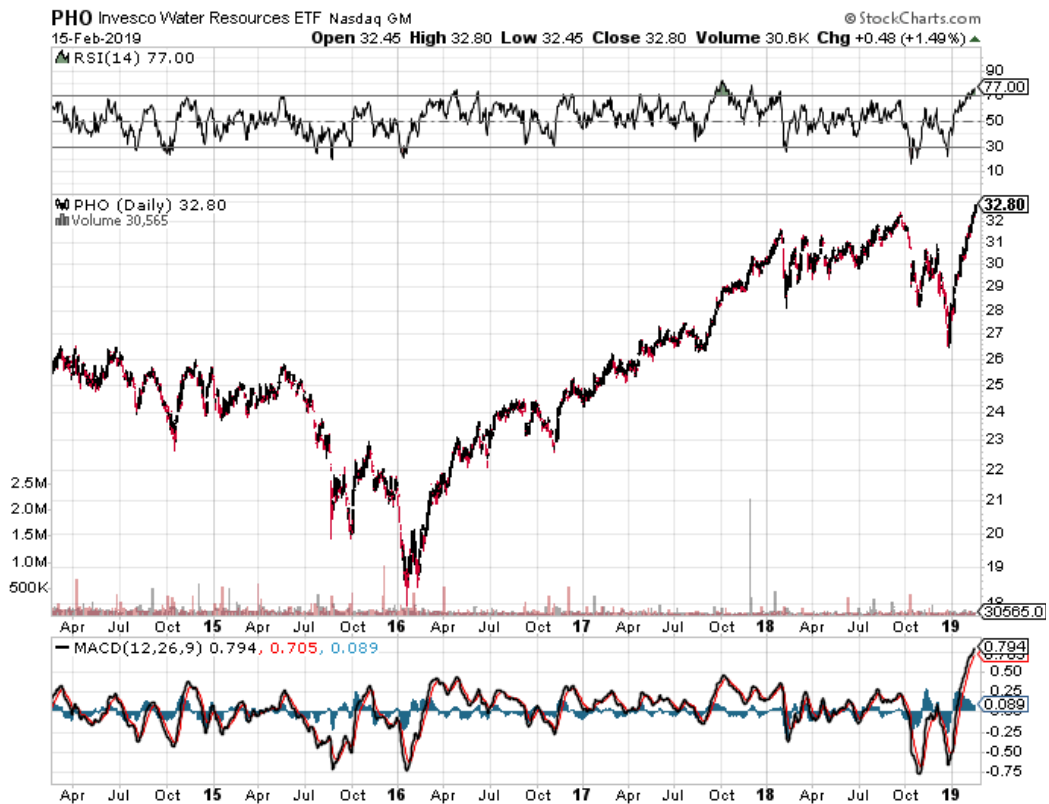

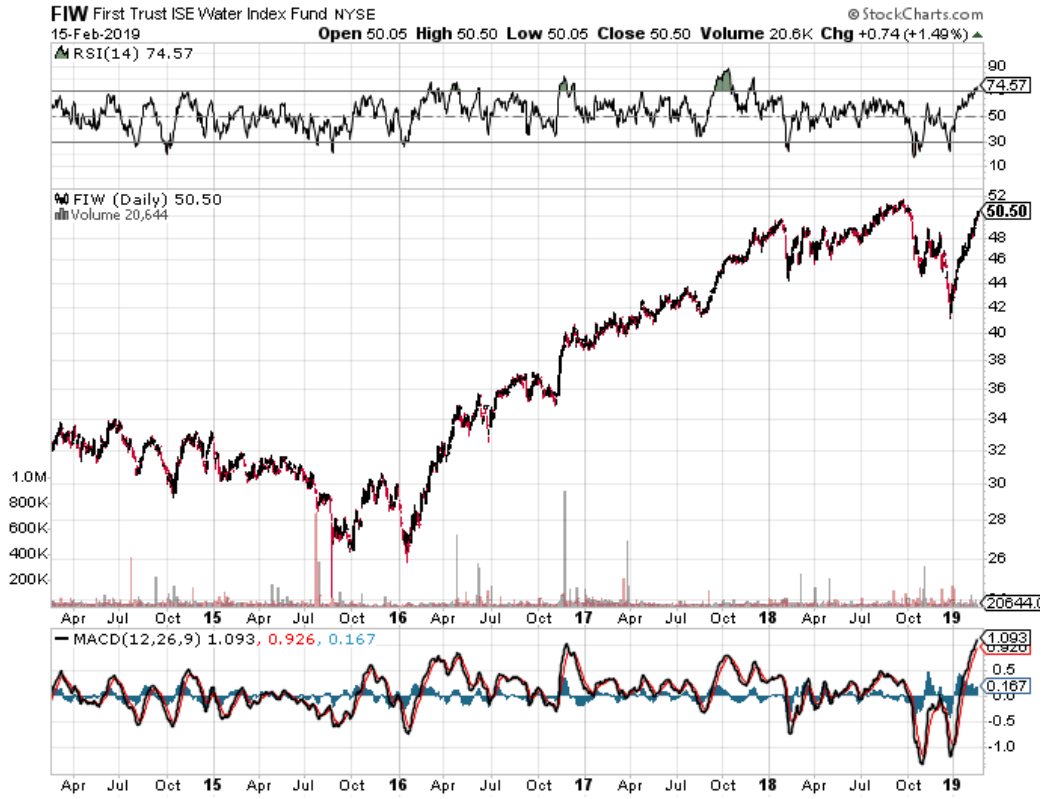



The U.S. is Still the Saudi Arabia of Freshwater

Click [HERE](#) to Learn more about Mad Hedge Fund Trader and the services we offer.

Biotech and Healthcare Stocks to Buy at the Bottom

One has to be truly impressed with the selloff in biotech and healthcare stocks since over the past year.

In recent years, there were signs that life was returning to this beleaguered sector. Then Mylan decided to raise the prices of its EpiPen by 400%, and it was back to the penalty box.

Let's gouge poor small children who may die horrible deaths if they can't afford our product. That sounds like a great marketing and PR strategy. **NOT!**

Once the top-performing sectors of 2015, they went from heroes to goats so fast that it made your head spin.

What I called "The ATM Effect" kicked in big time.

That's when frightened investors run to the sidelines and sell their best stocks to raise cash. After all, no one wants to sell other stocks for a loss and admit defeat, at least in front of their clients.

It's not that the companies themselves were without blood on their hands. Valuations were getting "stretched" at some point - to use the polite term - after a torrid five-year run.

Gilead Sciences (GILD) soaring from \$18 to \$125?

Celgene (CELG) rocketing from \$20 to \$142?

It has been a performance for the ages.

If a financial advisor *wasn't* in healthcare, chances are that he is driving a taxi for Uber in a bad neighborhood by now.

Then there was *The Tweet That Ate Wall Street*.

The biotech and healthcare stocks are a screaming "BUY" at these levels, provided you ignore Mylan (MYL), now the poster boy for corporate greed.

It's a political call I can only make after spending years in the White House, and a half century following presidential elections.

It's easy to understand why these stocks were so popular, and are found overflowing to the brim in client portfolios and personal 401k's and IRA's.

We are just entering a Golden Age for biotech and healthcare.

Profit growth for many firms is exceeding 20% a year. Hyper-accelerating biotechnology is rapidly bringing to the market dozens of billion dollar earning drugs that were, until recently, considered in the realm of science fiction.

Yet, we have only just gotten started. Cures for cancer, heart disease, arthritis, diabetes, AIDS, and dementia? You can take your pick.

Most biotech and healthcare stocks have given up all of their 2015 gains. Here is a chance to Hoover up the highest growing companies in the U.S. at 2014 prices.

If you missed biotech and healthcare the first time around, you've just been given a second chance at the brass ring.

Here's a list of five top quality names to get your feet wet:

Gilead Sciences (GILD) – Has the world's top hepatitis cure, which it sells for \$80,000 per treatment. For a full report, see the next piece below.

Celgene (CELG) – A biotech firm that specializes in cancer cures (thalidomide) and inflammatory diseases. It also produces Ritalin for the treatment of ADHD.

Allergan (AGN) – Has the world's third-largest low-cost generic drug business. In addition, it has built a major portfolio of drug therapies through more than two dozen acquisitions over the past decade.

Regeneron (REGN) – Already has a great anti-inflammatory drug, and is about to market a blockbuster anti-cholesterol drug that will substantially reduce heart disease.

HCA Holdings (HCA) – Is the world's largest operator of for-profit healthcare facilities in the world.

If you want a lower risk, more diversified play in the area, you can buy the Health Care Select Sector SPDR (XLV). Please note that a basket of stocks is going to deliver a fraction of the volatility of single stocks.

Therefore, we have to be more aggressive with our positioning to make any money, picking call option strikes that are closer to the money.

Johnson and Johnson (JNJ) is the largest holding in the (XLV), with a 12.8% weighting, while Gilead Sciences (GILD) is the fourth, with a 5.1% share. For a list of the largest components of this ETF, please [click here](#).

The other classic play in this area is the Biotech iShares ETF (IBB) issued by BlackRock ([click here](#)).

Their largest holding is Biogen (BIIB), followed by Gilead Sciences (GILD), Celgene (CELG), Amgen (AMGN), and Regeneron Pharmaceuticals (REGN).

I'll be shooting out **Trade Alerts** on biotech and healthcare names as soon as I think the coast is clear.

Until then, enjoy the ride!

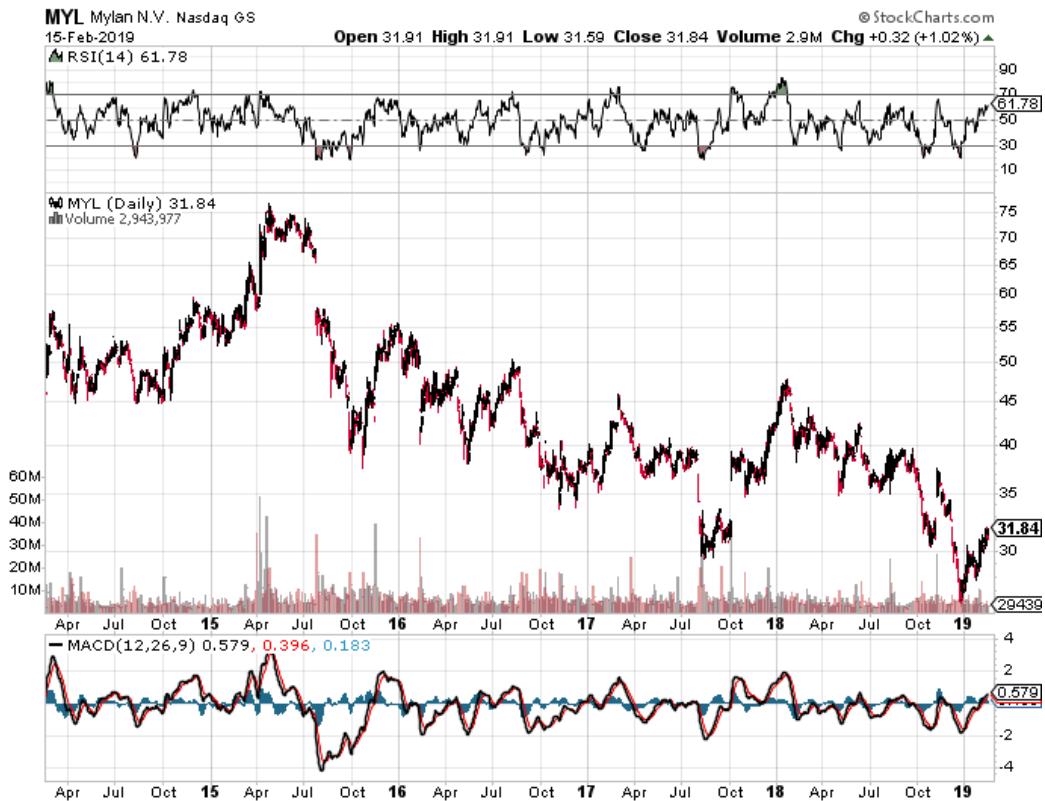

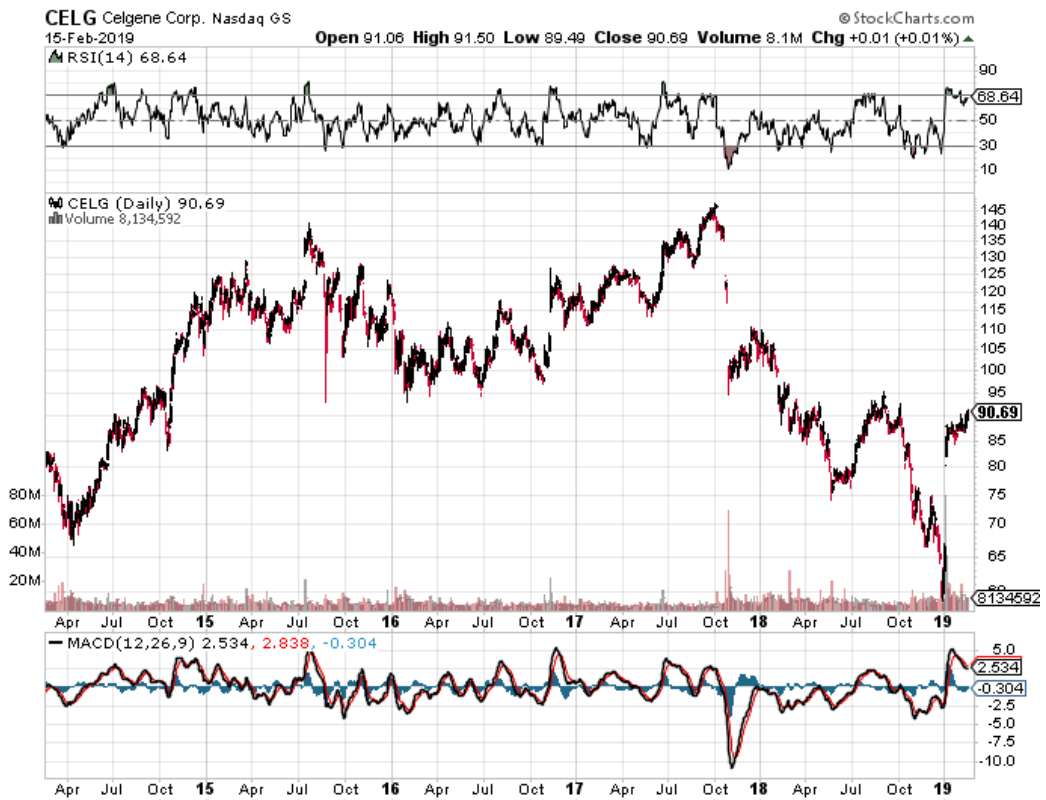
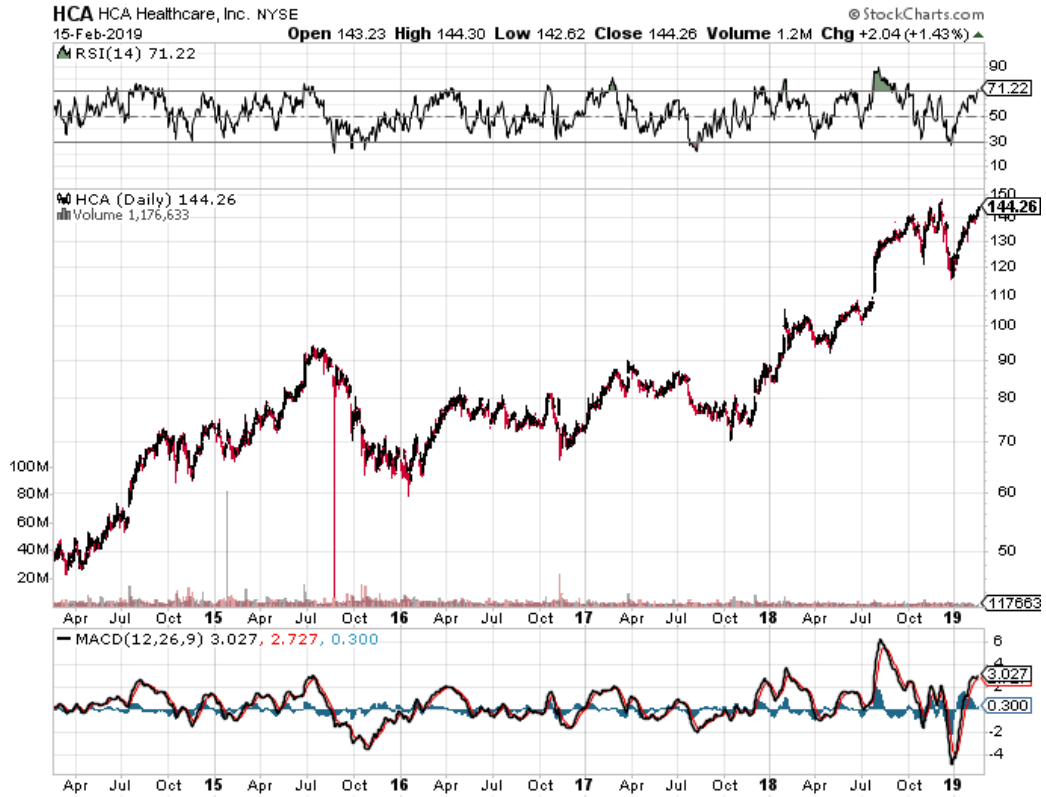

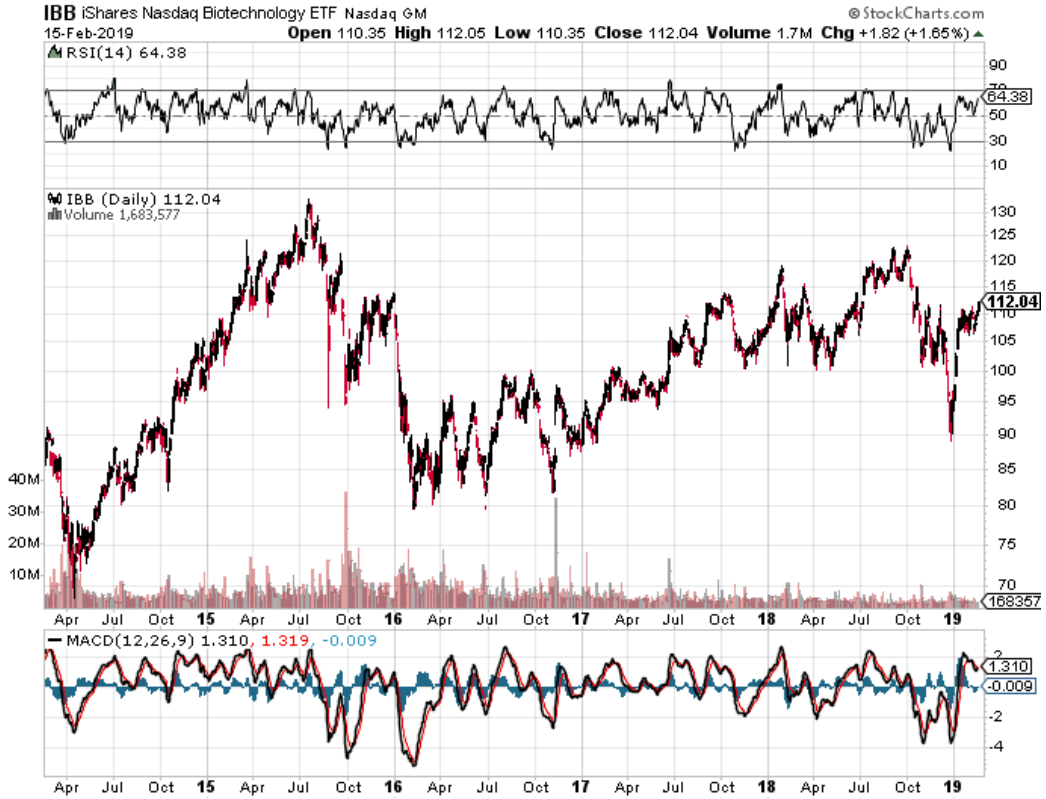

Say You Were A Pharmaceutical Investor, Did You?

Click [HERE](#) to Learn more about Mad Hedge Fund Trader and the services we offer.

The Ultra Bull Argument for Gold

Now that the barbarous relic is finally back in fashion, how high could it really go?

It turns out that gold is **THE** deflationary asset to own. Who knew?

I was an unmitigated bear on the price of gold after it peaked in 2011. In recent years, the world has been obsessed with yields, chasing them down to historic levels across all asset classes.

However, now that much of the world already has, or is about to have negative interest rates, a bizarre new kind of mathematics applies to gold ownership.

Gold's problem used to be that it yielded absolutely nothing, cost you money to store, and carried hefty transactions costs. That asset class didn't fit anywhere in a yield obsessed universe.

Now we have a horse of a different color.

Europeans wishing to put money in a bank have to pay for the privilege to do so. Place €1 million on deposit in an overnight account, and you will have only 996,000 Euros in a year. You just lost 40 basis points on your -0.40% negative interest rate.

With gold, you still earn zero, an extravagant return in this upside down world. All of a sudden, zero is a win.

For the first time in human history, that gives you a 40-basis point yield advantage over Euros. Similar numbers now apply to Japanese yen deposits as well.

As a result, the numbers are so compelling that it has sparked a new gold fever among hedge funds, and European and Japanese individuals alike.

Websites purveying investment grade coins and bars crashed multiple times in a week at some point due to overwhelming demand (I occasionally have the same problem). Some retailers have run out of stock.

Years ago, the fever went pandemic as silver rocketed 14.28%, and others like Platinum (PPLT) and Palladium (PALL) were also frantically bid.

So I'll take this opportunity to review a short history of the gold market (GLD) for the young and the uninformed.

Since it peaked in the summer of 2011, the barbarous relic was beaten like the proverbial red-headed stepchild, dragging silver (SLV) down with it. It faced a perfect storm.

Gold was traditionally sought after as an inflation hedge. However, with economic growth weak, wages stagnant, and much work still being outsourced abroad, **deflation** became rampant. The biggest buyers of gold in the world, the Indians, have seen their purchasing power drop by half, thanks to the collapse of the rupee against the U.S. dollar. The government increased taxes on gold in order to staunch precious capital outflows.

You could also blame China for declining interest in the yellow metal since it is now in its fifth year of falling economic growth.

Chart gold against the Shanghai index, and the similarity is striking, until negative interest rates became widespread in 2016.

The brief bid gold caught in 2015 over war fears in Syria, the Ukraine, and then Iraq was worth an impressive \$160 rise.

That is when the diplomats got involved and hostilities were at least delayed, causing gold to roll over like the Bismarck.

In the meantime, gold supply/demand balance was changing dramatically.

While no one was looking, the average price of gold production soared from \$5 in 1920 to \$1,300 today. Over the past 100 years, the price of producing gold has risen four times faster than the underlying metal.

It's almost as if the gold mining industry is the only one in the world that sees real inflation, since costs soared at a 15% annual rate for the past five years.

This is a function of what I call "peak gold." They're not making it anymore. Miners are increasingly being driven to higher risk, more expensive parts of the world to find the stuff.

You know those tires on heavy dump trucks? They now cost \$200,000 each, and buyers face a three-year waiting list to buy one.

Barrick Gold (ABX) didn't try to mine gold at 15,000 feet in the Andes, where freezing water is a major problem because they like the fresh air.

What this means is that when the spot price of gold fell below the cost of production, miners simply shut down their most marginal facilities, drying up supply. That has recently been happening on a large scale.

Barrick Gold, a client of the *Mad Hedge Fund Trader*, can still operate, as older mines carry costs go all the way down to \$600 an ounce.

No one is going to want to supply the sparkly stuff at a loss. That should prevent gold from falling dramatically.

I am constantly barraged with emails from gold bugs who passionately argue that their beloved metal is trading at a tiny fraction of its true value, and that the barbarous relic is really worth \$5,000, \$10,000, or even \$50,000 an ounce (GLD).

They claim the move in the yellow metal we are seeing now is only the beginning of a 30-fold rise in prices, similar to what we saw from 1972 to 1979 when it leapt from \$32 to \$950.

So, when the chart below popped up in my inbox showing the gold backing of the U.S. monetary base, I felt obligated to pass it on to you to illustrate one of the intellectual arguments these people are using.

To match the gain seen since the 1936 monetary value peak of \$35 an ounce when the money supply was collapsing during the Great Depression and the double top in 1979 when gold futures first tickled \$950, this precious metal has to increase in value by 800% from the recent low. That would take our barbarous relic friend up to **\$8,400 an ounce**.

To match the move from the \$35/ounce 1972 low to the \$950/ounce 1979 top in absolute dollar terms, we need to see another 27.14 times move to \$28,497/ounce.

Have I gotten you interested yet?

I am long-term bullish on gold, other precious metals, and virtually all commodities for that matter. However, I am not that bullish. These figures make my own \$2,300/ounce long-term prediction positively wimp-like by comparison.

The seven-year spike up in prices we saw in the 70s, which found me in a very long line in Johannesburg, South Africa, to unload my own Krugerrands in 1979, was triggered by a number of one-off events that will never be repeated.

Some 40 years of unrequited demand was unleashed when Richard Nixon took the U.S. off the gold standard and decriminalized private ownership in 1972. Inflation then peaked around 20%. Newly enriched sellers of oil had a strong historical affinity with gold.

South Africa, the world's largest gold producer, was then a boycotted international pariah and teetering on the edge of disaster. We are nowhere near the same geopolitical neighborhood today, and hence, my more subdued forecast.

But then again, I could be wrong.

In the end, gold may have to wait for a return of inflation to resume its push to new highs. The previous bear market in gold lasted 18 years, from 1980 to 1998, so don't hold your breath. What should we look for? The surprise that your friends get an out of the blue pay increase, the largest component of the inflation calculation.

This is happening now in technology, but nowhere else. When I visit open houses in my neighborhood in San Francisco, half the visitors are 30-somethings wearing hoodies offering to pay cash.

It could be a long wait for *real* inflation, possibly into the mid 2020s, when shocking wage hikes spread elsewhere.

As for the many investment advisor readers who have stayed long gold all along to hedge their clients' other risk assets, good for you.

You're finally learning!

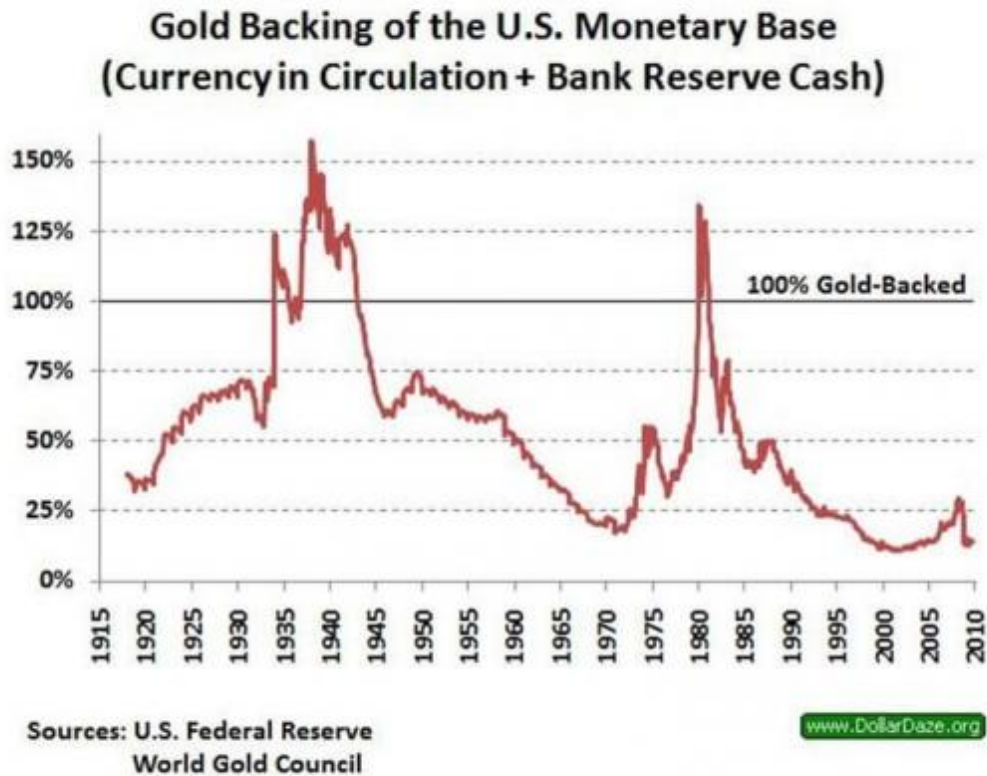

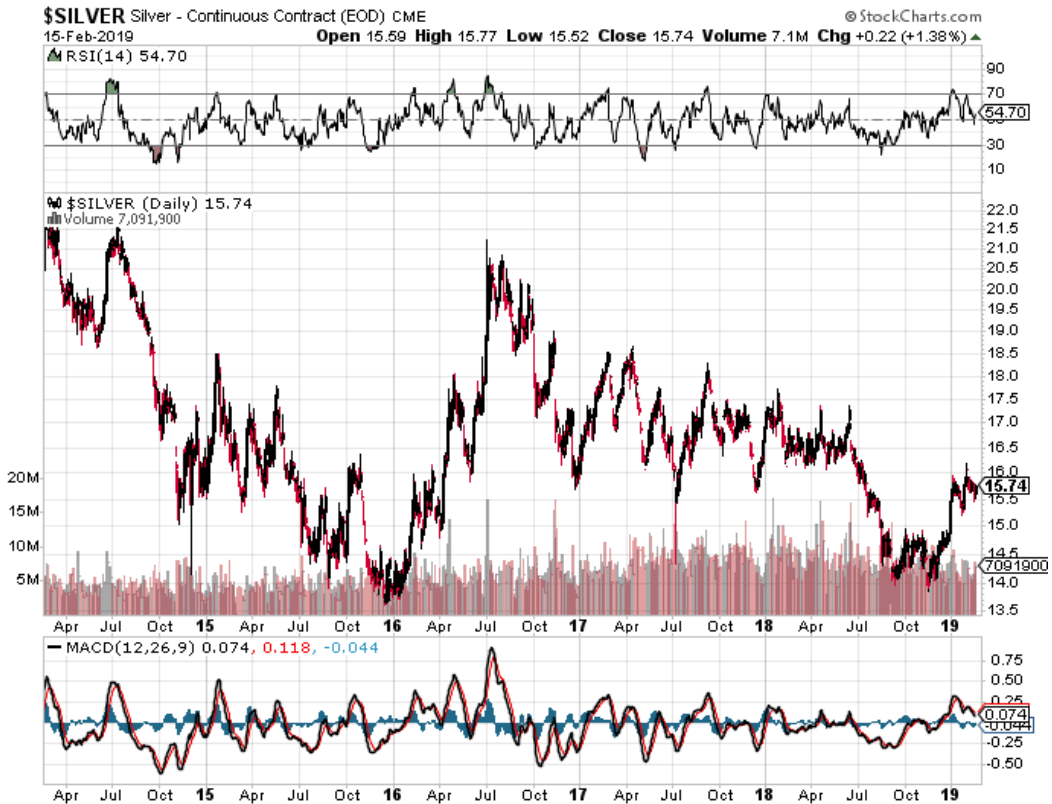
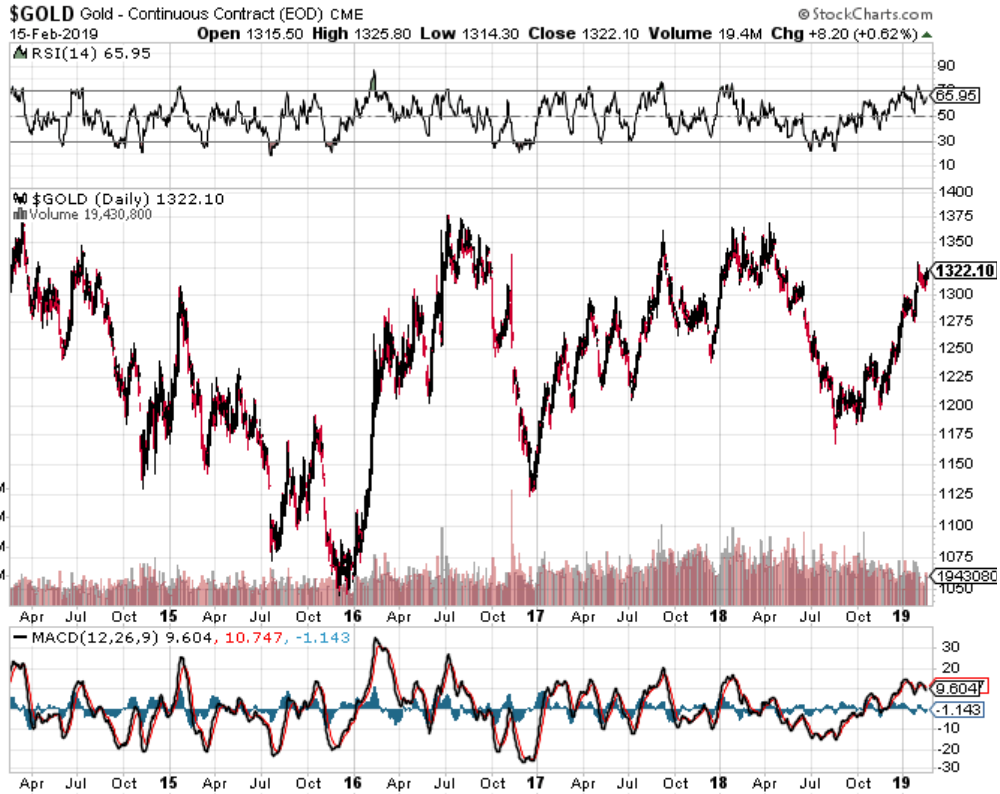

PALL ETFS Physical Palladium Shares NYSE

15-Feb-2019 © StockCharts.com
Open 136.20 High 136.71 Low 136.00 Close 136.54 Volume 26.4K Chg +1.54 (+1.14%) ▲

▲ RSI(14) 68.60

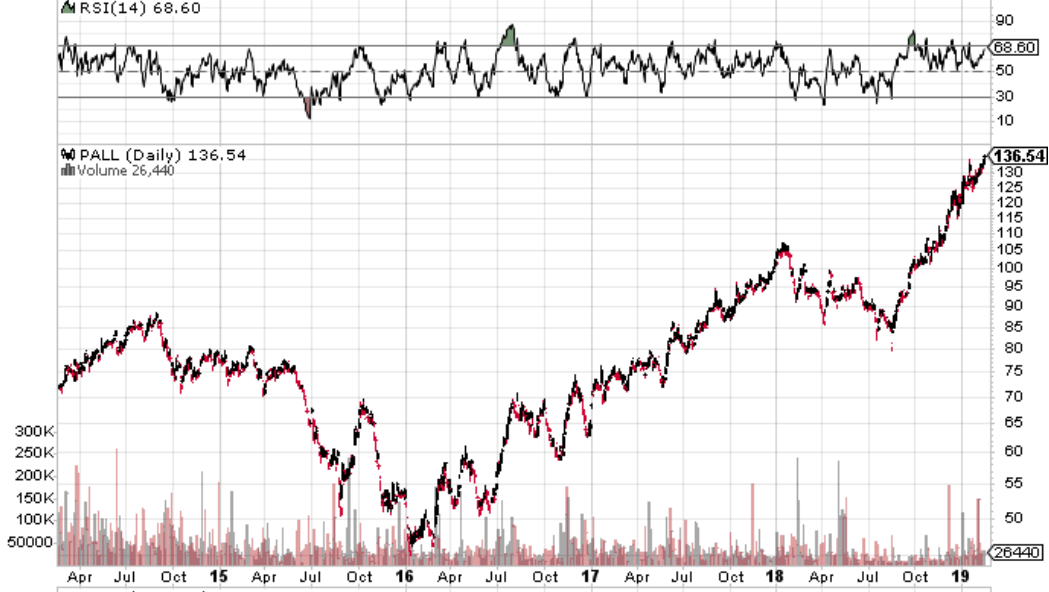

— MACD(12,26,9) 2.851, 2.483, 0.368



PPLT ETFS Physical Platinum Shares NYSE

15-Feb-2019 © StockCharts.com
Open 75.00 High 76.55 Low 74.90 Close 76.52 Volume 144.1K Chg +1.92 (+2.57%) ▲

▲ RSI(14) 51.76

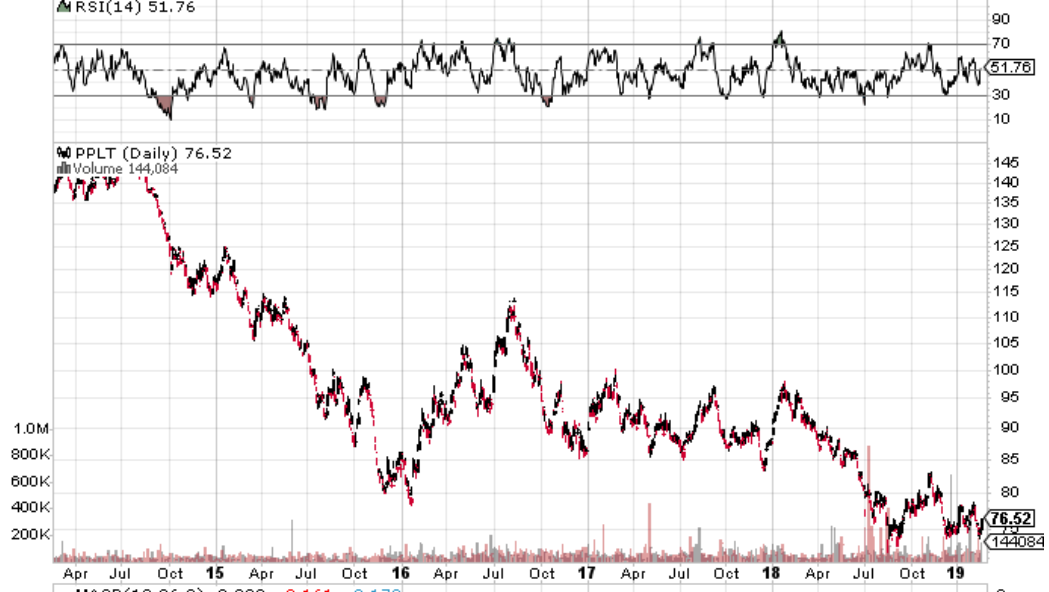

— MACD(12,26,9) -0.333, -0.161, -0.172



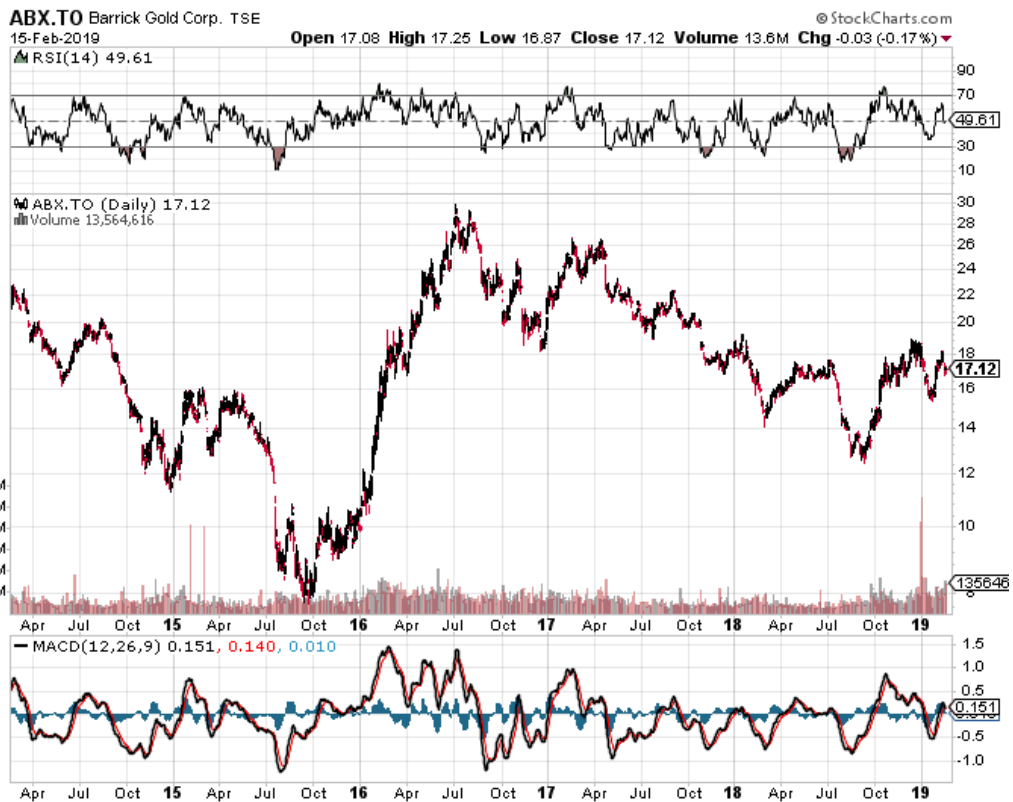
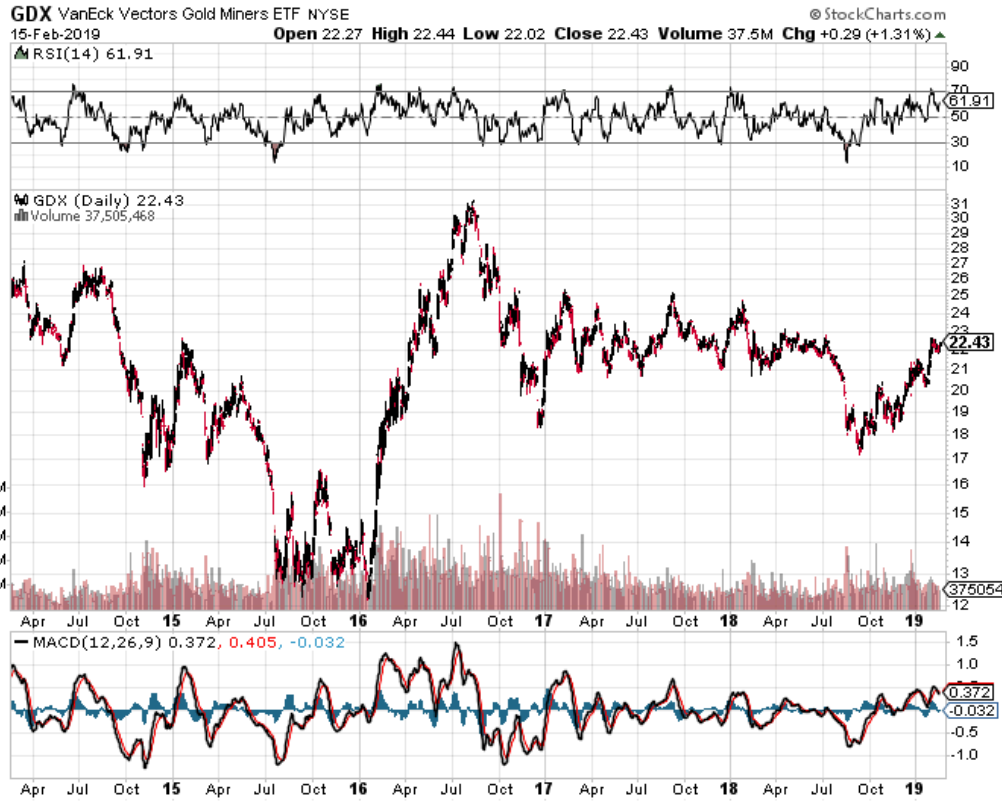



Click [HERE](#) to Learn more about Mad Hedge Fund Trader and the services we offer.

Diamonds Are Still an Investor's Best Friend

If you forgot to buy your loved one a birthday present and spent a week sleeping on the sofa eating canned food and cleaning out the cat box, you now have a chance to redeem yourself. A revolutionary new website exists called Mazal Diamond, which promises to turn the online jewelry business upside down. I went to the privately held company's website at <http://www.mazaldiamond.com> and found an entertaining assortment of free tools.

You can design your own jewelry, and even order a custom cut, which Mazal will supply out of its massive 100,000-stone inventory. You can also figure out if the jeweler down the street is trying to rip you off.

Just for fun, I had the diamond I bought for my late wife appraised, which I bought from a Hasidic Jew in an alley off of Manhattan's West 47th Street. He kept his inventory hidden in an envelope in his sock.

How times have changed! The two carat, VVS1, round cut, yellow diamond that I paid \$3,000 for in 1977, would fetch \$39,800 today. Great trade!

Mazal Diamond's game-changing advantage is that it cuts, designs, and manufactures its own jewelry, enabling the company to undercut prices offered by established industry leaders.

In fact, the \$30-billion-a-year diamond industry is undergoing radical change by moving online, much the same way as the book, music and travel industry have gone.

Your local neighborhood jewelry store is about to get wiped out or become a quaint relic. Blue Nile (NILE), now owned by a private company, pioneered the way and instantly became the 800-pound gorilla. The company cut costs by keeping inventories low, relying instead on a secretive web of anonymous suppliers.

Now, second-generation entrants are snapping at its heels and eating its lunch with polished websites, better service, and lower prices, seducing potential customers with free diamond blogs. Mazal Diamond even offers a year of free insurance.

They are getting a boost from the 50% price gain a woman's best friend has seen since the March 2009 stock market bottom, taking them back to pre crash levels.

The U.S. accounts for about half the world market, so the new frugality will be a challenge. That will be offset by flight to safety purchases by inflation-wary Americans and new demand from the emerging market middle class.

Investment grade diamonds have been steady earners, gaining an average 5% a year over the past three decades. To avoid another week on the sofa, you might even think about buying next year's Valentine's surprise early.

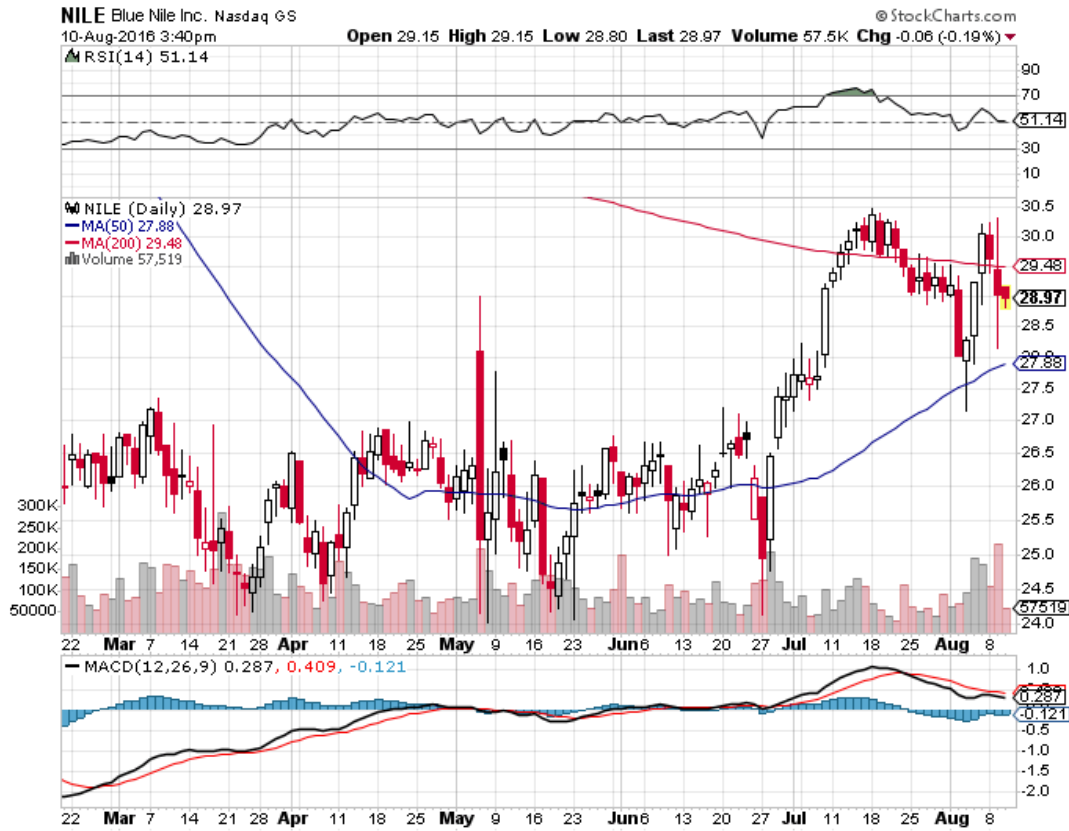

Click [HERE](#) to Learn more about Mad Hedge Fund Trader and the services we offer.

The Ten Baggers in Cybersecurity

The threat to America's national security does not come from ISIS, Iran, Russia, or China. It is an online hack attack.

That is the view of General Keith B. Alexander, who formerly served as the head of U.S. Cyber Command after a lifetime in the intelligence business, the country's principal online warrior.

I discovered a long time ago that a retired general can be one of the most valuable sources of information about long-term capital market trends. After a career spent exercising discretion and keeping opinions to themselves, the dam breaks.

Sometimes, I am amazed at what I can pick up. Of course, it helps that my own top-secret clearance is still valid.

So, when the chance arose to secretly meet Alexander at an undisclosed location, I jumped at it. The general argues that the U.S. is the preeminent online target because we have so much to lose. A concentrated attack could simultaneously cripple all communications, power supply, and financial markets. Life, as we know it, would completely grind to a halt.

The greatest cyber attacks are yet to come.

The U.S. has no shortage of enemies on this front. Vladimir Putin is attempting to reassemble the old Soviet Union. Iran is engaged in numerous adventures throughout the Middle East. China is expanding its empire at every opportunity.

Alexander knows what he is talking about.

He is a retired four-star general who served as director of the National Security Agency (DIRNSA), chief of the Central Security Service (CHCSS) and commander of the United States Cyber Command.

He graduated from West Point, Class of 1974, along with three other future four-star generals, including former CIA chief David Petraeus, and former Chairman of the Joint Chiefs of Staff Martin Dempsey, whom I both know and about whom I have written.

While head of Army Intelligence, he was in charge of 10,700 spies and eavesdroppers worldwide. He has three master's degrees in business, physics, and systems technology. A lightweight, he is not.

Alexander expressed his concern that ISIS was using Facebook (FB) to build a global terrorist network. Google (GOOG) has lost \$10 billion in revenues to cyberattacks. The government's controversial collection of metadata, now at risk from the republican-controlled congress, was instrumental in preventing a plot to blow up the New York subway system in 2009.

Coordination among federal agencies is still a major problem. When the NSA discovered that CIA computers may have been compromised, they asked to take a look. They were refused. Finally, pressure from the president opened the doors. The NSA discovered 1,500 Russian malware programs on agency mainframes and they scrubbed them in only 22 hours.

Big data programs on U.S. computers in Iraq were instrumental in identifying, locating, and destroying much of the leadership of Al-Qaeda.

Ironically, the U.S. military has broken up more hack attacks against European targets than U.S. ones, thanks to their weaker defenses.

And here is the part that always blows my mind. Military men are often clueless about the market implications of their own far-reaching conclusions.

That is where I step in.

It looks like the cybersecurity sector, one of the best market performers during the first half of 2015, is about to take off like a rocket once again. There could be another 20% to 30% in it this year. We are only one hack attack away from another blockbuster rally.

The near destruction of Sony (SNE) by North Korean hackers in 2014 has certainly put the fear of God into corporate America. Apparently, they have no sense of humor whatsoever north of the 38th parallel.

As a result, there is a generational upgrade in cybersecurity underway, with many potential targets boosting spending by multiples.

Alexander suggested that the world will probably never again see large-scale armies fielded by major industrial nations. Wars of the future will be fought online, as they have been silently and invisibly over the past 15 years.

All of those trillions of dollars spent on big ticket, heavy metal weapons systems are pure pork designed by politicians to buy voters in marginal swing states.

The money would be far better spent where it is most needed, on the cyber warfare front. Alexander is not alone in these views among America's senior military leadership.

The problem is that when wars become cheaper, you fight more of them, as is the case with online combat.

You probably don't know this, but during the Bush administration, the Chinese military downloaded the entire contents of the Pentagon's mainframe computers at least seven times. This was a neat trick because these computers were in stand-alone, siloed, electromagnetically shielded facilities not connected to the Internet in any way.

In the process, they obtained the designs of all of our most advanced weapons systems, including our best nukes. What have they done with this top-secret information?

Absolutely nothing.

Like many in senior levels of the U.S. military, the Chinese have concluded that these weapons are a useless waste of valuable resources. Far better value-for-money are more hackers, coders, and servers, which the Chinese have pursued with a vengeance.

You have seen this in the substantial tightening up of the Chinese Internet through the deployment of the Great Firewall, which blocks local access to most foreign websites.

Try sending an email to someone in the Middle Kingdom with a Gmail address. It is almost impossible. This is why Google (GOOG) closed its offices years ago.

As a member of the Joint Chiefs of Staff told me, "The greatest threat to national defense is wasting money on national defense."

Our nation's military is clamoring for more money to take the cyber war to the enemy. Instead, they are effectively being given more horses, cavalry sabers, and cannon to fight it. No wonder they are eternally frustrated.

The implication is that I need to go out and buy Palo Alto Networks (PANW) once again, a company that I have been recommending since I started covering the industry years ago. Since then, the shares have skyrocketed some 162%.

Palo Alto Networks, Inc. is an American network security company based in Santa Clara, California, just across the water from my Bay Area office.

The company's core products are advanced firewalls designed to provide network security, visibility, and granular control of network activity based on application, user, and content identification.

Palo Alto Networks competes in the unified threat management and network security industry against Cisco (CSCO), FireEye (FEYE), Fortinet (FTNT), Check Point (CHKP), Juniper Networks (JNPR), and Cyberoam, among others.

The really interesting thing about this industry is that there are no losers. That's because companies are taking a layered approach to cybersecurity, parceling out contracts to many of the leading firms at once—looking to hedge their bets.

To say that top management has no idea what these products really do would be a huge understatement. Therefore, they buy all of them.

This makes a basket approach to the industry more feasible than usual. You can do this through buying the \$1.5 billion capitalized PureFunds ISE Cyber Security ETF (HACK), which boasts Cyber-Ark Software (CYBR), Infoblox (BLOX), and FireEye (FEYE) as its three largest positions. (HACK) has been a hedge fund favorite since the Sony attack.

For more information about (HACK), please [click here](#).

If you are looking for value plays in this area, you can forget about it. Neither (PANW) nor (FEYE) generate any net earnings. Much as with Tesla (TSLA), you are not betting on what the earnings are today, but what they might be worth in a decade, when the market is infinitely larger.

Think of them as faith-based investments.

Could the shares of today's crop of cybersecurity companies rise tenfold from here? Absolutely! Actually, 10 might be a low number. If nothing else, the entire industry has become prime takeover bait, offering potential instant profits.

Oh, and by the way, Alexander thinks that drone surveillance of U.S. citizens is coming in the near future. Look out above!

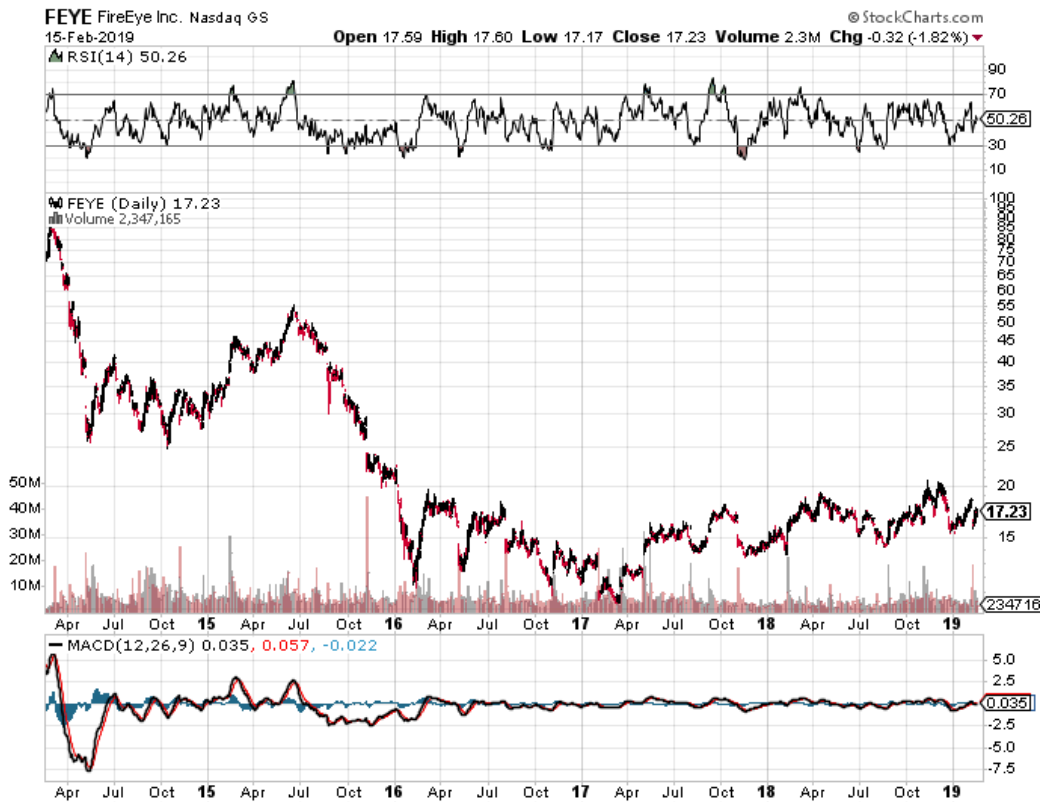

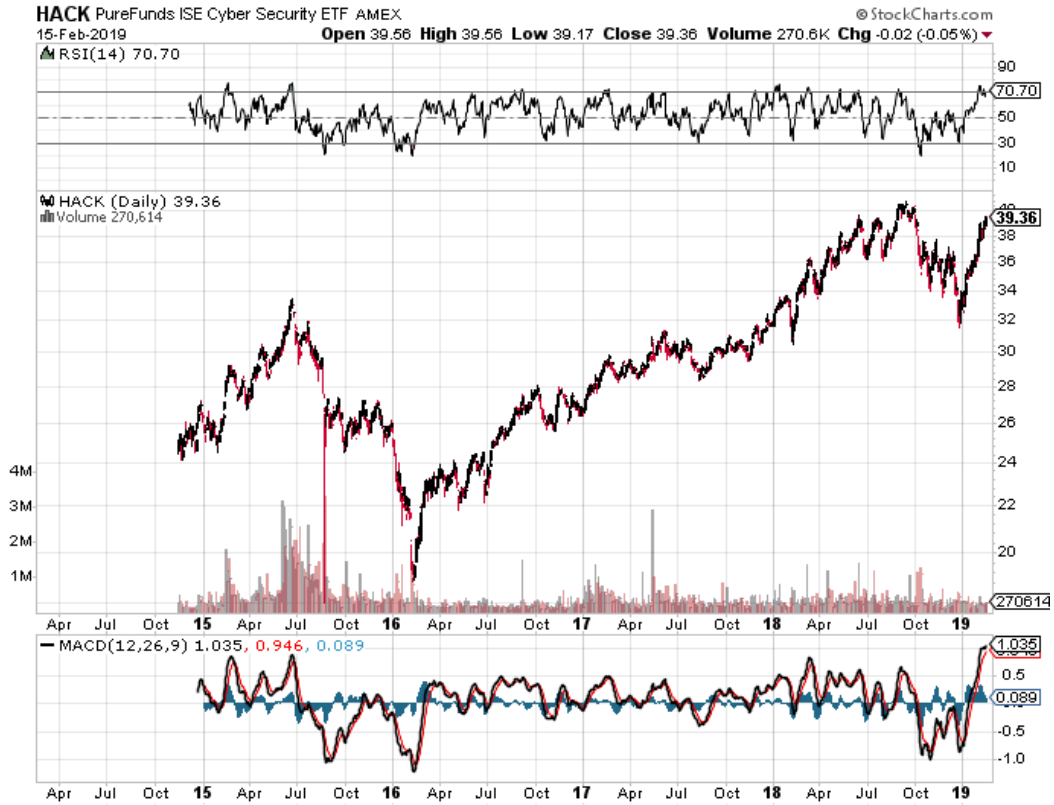

Click [HERE](#) to Learn more about Mad Hedge Fund Trader and the services we offer.

Welcome to the Deflationary Century

Ignore the lessons of history, and the cost to your portfolio will be great. Especially if you are a bond trader!

In Britain, they celebrated something unusual recently. The government reported the first year-on-year decline in consumer prices in 54 years (see chart below).

In fact, prices for the things they buy day to day were 0.1% lower than they were 12 months before.

Meet deflation, up-front and ugly.

If you looked at a chart for data from the United States, they would not be much different, where consumer prices are showing a feeble 0.4% YOY price gain. This is miles away from the Federal Reserve's own 2% annual inflation target.

We are not just having a deflationary year or decade. We may be having a deflationary century. If so, it will not be the first one.

The 19th century saw continuously falling prices as well. Read the financial history of the United States, and it is beset with continuous stock market crashes, economic crisis, and liquidity shortages.

The union movement sprung largely from the need to put a break on falling wages created by perennial labor oversupply and sub-living wages.

Enjoy riding the New York subway? Workers who were paid 10 cents an hour built it more than 120 years ago. It couldn't be constructed today, as other more modern cities have discovered. The cost would be wildly prohibitive.

The causes of 19th century price collapse were easy to discern. A technology boom sparked an industrial revolution that reduced the labor content of end products by ten- to hundredfold. Instead of employing a 100 women for a day to make 100 spools of thread, a single man operating a machine could do the job in an hour.

The dramatic productivity gains swept through then developing economies like a hurricane. The jump from steam to electric power during the past quarter of the century took manufacturing gains a quantum leap forward.

If any of this sounds familiar, it is because we are now seeing a repeat of the exact same impact of accelerating technology. Machines and software are replacing human workers faster than their ability to retrain for new professions.

This is why there has been no net gain in middle class wages for the past 30 years. It is the cause of the structural high U-6 “discouraged workers” employment rate, as well as the millions of millennials still living in their parents’ basements.

Instead of steam and electric power, it is now the Internet, cheap computing power, global broadband, and software that is swelling the ranks of the jobless.

What’s more, technology gains are now going hyperbolic to a degree never seen before in civilization.

To the above add the huge advances now being made in healthcare, biotechnology, genetic engineering, DNA-based computing, and big data solutions to problems.

If all the diseases in the world were wiped out, a probability within 30 years, how many jobs would that destroy?

Probably tens of millions.

So the deflation that we have been suffering in recent years isn’t likely to end anytime soon. In fact, it is just getting started.

Why am I interested in this issue? Of course, I always enjoy analyzing and predicting the far future, using the unfolding of the past half century as my guide. Then I have to live long enough to see if I’m right.

I did nail the rise of eight track tapes over six track ones, the victory of VHS over Betamax, the ascendance of Microsoft operating systems over OS2, and then the conquest of Apple over Microsoft. So, I have a pretty good track record on this front.

For bond traders especially, there are far-reaching consequences of a deflationary century. It means that there will be no bond market crash, as many are predicting, just a slow grind up in long-term interest rates instead.

Amazingly, the top in rates in the coming cycle may only reach the bottom of past cycles, around 3% for 10-year Treasury bonds (TLT), (TBT).

The soonest that we could possibly see real wage rises will be when a generational demographic labor shortage kicks in during the 2020s. That could be a decade off.

I say this not as a casual observer, but as a trader who is constantly active in an entire range of debt instruments.

So, the bottom line here is that there is additional room for bond prices to fall and yields to rise. But not by that much, given historical comparisons. Think of singles, not home runs.

It really will be just a trade. Thought you'd like to know.

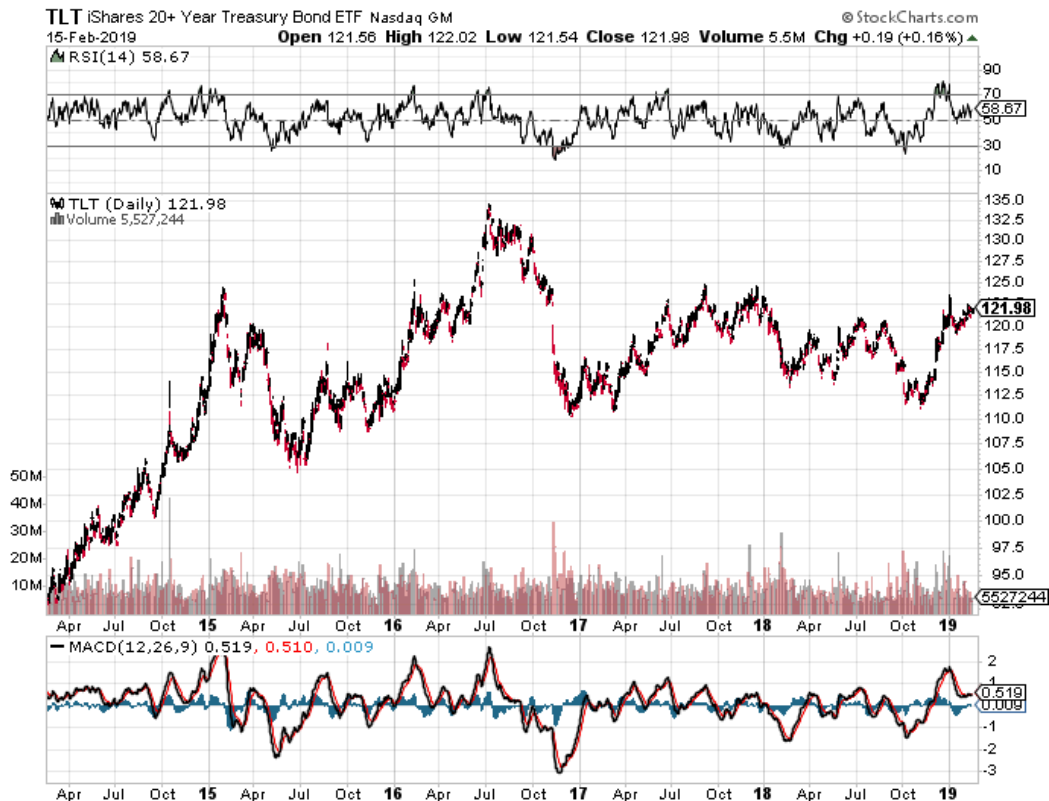

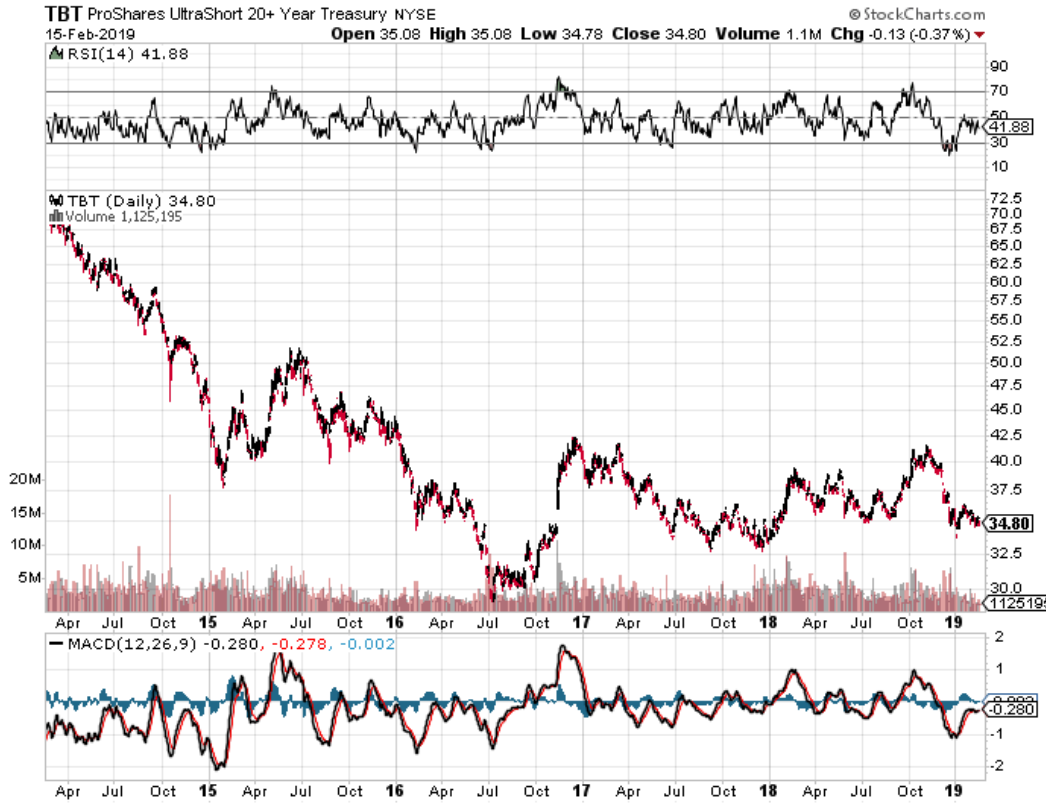

Try This at Your Peril

Click [HERE](#) to Learn more about Mad Hedge Fund Trader and the services we offer.

The Death of the Car

One of the goals of the *Diary of a Mad Hedge Fund Trader* is to identify major changes in the global economy early enough to get investors into the impacted shares early.

The death of the car is one of those trends, and it is still early, very early.

This is a very big deal.

Earlier in my lifetime, car production directly and indirectly accounted for one-third of the U.S. economy.

Much of the growth during our earlier Golden Ages, in the 1920s and the 1950s, was driven by a never-ending cycle of upgrades of our favorite form of transportation and the countless ancillary services needed to support them.

Today, 253 million automobiles and trucks prowl America's roads, about half the world's total, with an average age of 11.4 years.

The demise of this crucial industry started during the 2008 crash when (GM) and Chrysler (owned by Fiat) went bankrupt. Only more conservatively run Ford (F) survived on its own.

The government stepped in with massive bailouts. That was the cheaper option for the Feds, as the cost of benefits for an entire unemployed industry was far greater than the cost of the companies absorbed.

If it hadn't done so, the auto industry would have decamped for a new base near the technology hubs in California, and today would be a decade closer to their futures than they are now.

I'll break out the major directions the industry is now taking. Hint: It doesn't have much to do with traditional metal bashing.

The Car as a Peripheral

The important thing about a car today is not the car, but the various doodads, gizmos, and gadgets they stick in them. In this category you can include 24/7 4G wireless, full Internet access, mapping software, and learning programs.

(GM) is now installing more than 100 microprocessors in its vehicles to control and monitor various functions.

Good luck doing your own tune-ups.

The Car as a Service

When you think about it, automobile ownership is a wildly inefficient use of capital. It is usually a family's second largest expense, after their home, running \$30,000 to \$80,000.

It then sits unused in garages or public parking for 96% to 98% of the day. Insurance, maintenance, and liability costs can be off the charts.

What if your car were used 24/7, as is machinery in well-run industrial plants? Your cost drops by 96% to 98% to the point where it is almost free.

The sharing economy is the way to accomplish this.

We are already seeing several start-ups attempting to accomplish this in major U.S. cities, such as Zipcar, Car2Go, Getaround, Turo (formerly RelayRides), and City CarShare.

What happens to conventional car companies when consumers shift from ownership to sharing? Demand plunges by 96% to 98%.

Perhaps that is why auto shares (GM), (F) have performed so abysmally this year, despite record sales at a 17 million unit annual rate.

Self-Driving Technology

This is the hottest development area in the industry, with Apple (AAPL), Alphabet (GOOG), and the big European car makers committing thousands of engineers.

Let's say your car is now comfortably driving you to work, allowing you to read the morning papers and catch up on your email. Or maybe you're lazy and would rather watch the season finale for ***Game of Thrones***.

What else is possible?

How about if, instead of parking, your car drops you off, saving that exorbitant fee. Then it joins Uber, picking up local riders and paying for its own way. It then dutifully returns to pick you up at your office when it's time to go home.

Since the crash rate for computers is vastly lower than for humans, car insurance rates will collapse, gutting that industry.

Ditto for life insurance, as 35,000 people a year will no longer die in car crashes.

Half of all emergency room visits are the result of car accidents, so that business disappears too, dramatically shrinking health care costs in the process.

Driverless electric cars are totally silent, increasing the value of land near freeways.

Nor do they require much maintenance, as they have so few moving parts. Exit the car repair industry.

I could go on and on, but you get the general idea.

For more on the topic, please read "***Test Driving Tesla's Self Driving Technology***" by [clicking here](#).

Virtual Reality

After 30 years of inadequate infrastructure budgets, trying to get into any America city center is a complete nightmare.

Sometime ago, a cattle truck turned over on the Golden Gate Bridge, bringing traffic to a halt. Fortunately, a cowboy traveling to a nearby rodeo was able to unload his horse and lasso the errant critters (no, it wasn't me!).

Even if you get into the city, you will be greeted by a \$40 tab for a parking space. Hopefully, no one will smash your windows and steal your laptop (happened to me last year).

Why bother?

Thirty years ago, teleconferencing services pitched themselves as replacing the airplane.

Today, we are taking the next step, using Skype and GoToMeeting to conduct even local meetings, as we do at the ***Mad Hedge Fund Trader***.

Virtual reality is clearly the next step, providing a 3D, 360-degree experience that makes you feel like you and your products are actually there.

Better to leave that car in the garage where it can get a top up on its charge. BART is cheaper anyway, when it runs.

New Materials

We are probably five years away from adopting the carbon fiber technology now used in the aircraft industry for mass-market cars. Carbon has one-tenth the weight of steel, with 10 times the strength.

The next great leap forward for electric cars won't be through better batteries. It will come through a 70% reduction of the mass of a car, tripling ranges with existing technology.

San Francisco Becomes the Car Capital of the World

This will definitely **NOT** happen, as sky-high rents assure that the city by the bay will never attract large, labor-intensive industries.

Instead, the industry will develop much as the one for smartphones. The high value-added

aspects, design and programming will stay in California.

The assembly of the chassis, the body, and the rest of the vehicle will be best done in low cost, tax free states with a lot of land, such as Texas and Nevada.

What will happen to Detroit? It has already become a favored destination of new venture capital financial start-ups. The cost of offices and housing is virtually free.

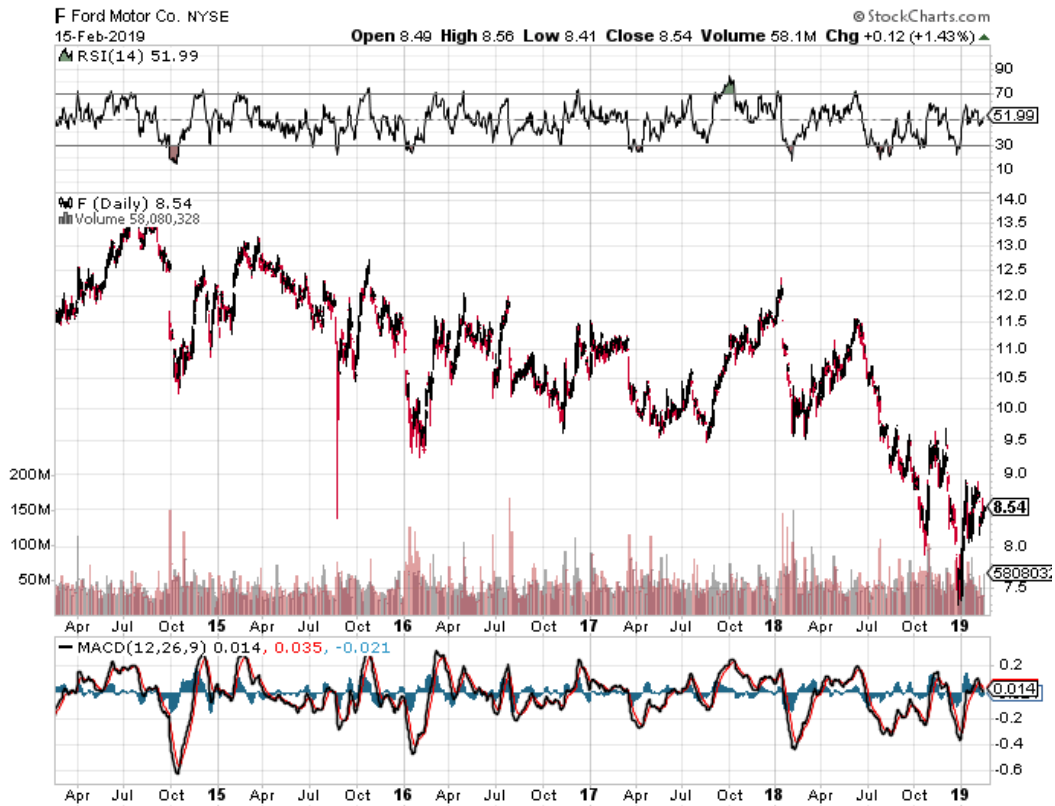

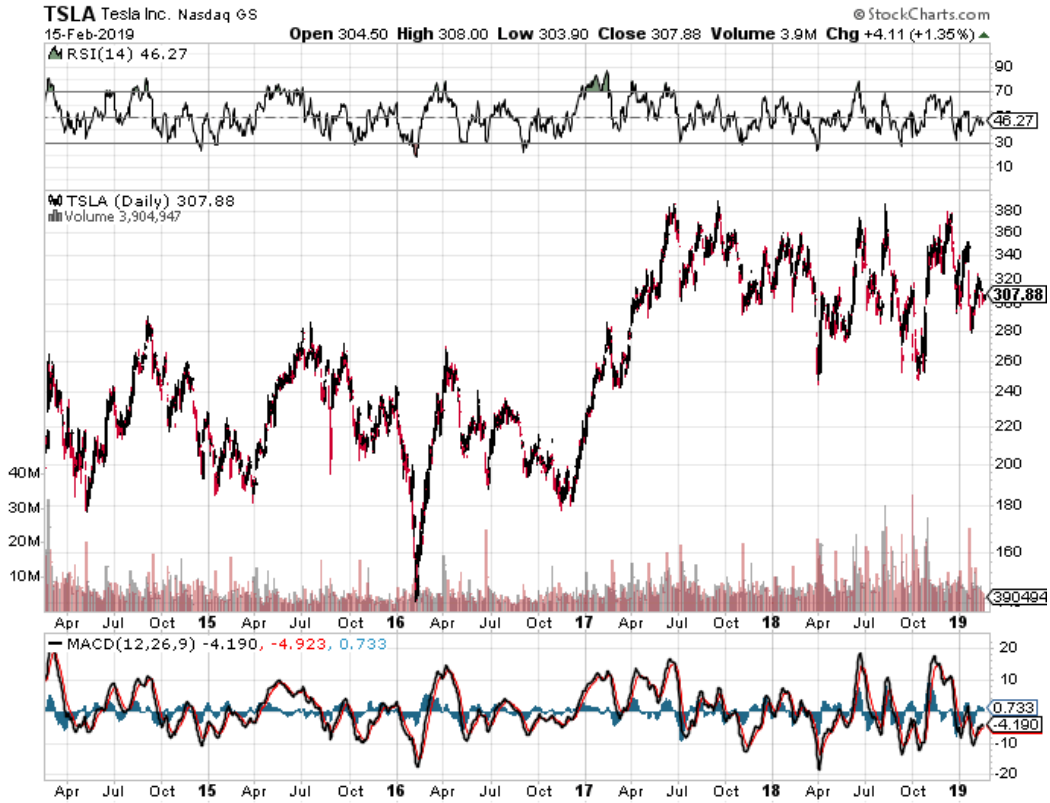

Seems Alive to Me

Click [HERE](#) to Learn more about Mad Hedge Fund Trader and the services we offer.

Print Your Own Car

I am ever on the lookout for disruptive technologies that lead to great investment opportunities. Sitting here next door to Silicon Valley, that is not hard to do.

So I watched my TV with utter amazement the other day when I saw a 3D printer create an entire car from scratch. It took ten hours to build the body, and the rest of the day to bolt on the electric motors, axels, wheels, and the rest of the parts.

Beyond the drivetrain, the vehicle has only 50 parts. This compares to the 5,000 or 6,000 parts needed for a conventional car. There's a gigantic labor and cost saving right there.

I have to admit that I came late to the 3D printing scene. When hobbyists started making colorful figurines on their printers a few years ago, I thought it no more than a niche of a few passionate geeks who are in such abundance here.

That was a good thing because the initial batch of stock market plays all went meteoric, then crashed and burned.

Such is often the case with cutting-edge technologies. You often don't generate real profits until you get the second or third generation.

That's the way the personal computer started which went mainstream with incredible speed in the early 1980s (to get the flavor of the day, watch the hit AMC series "**Halt and Catch Fire**").

Then my biotech friends told me they were printing human organs substituting ink with cells. After that, I discovered that Elon Musk was using 3D printers to build rocket engine parts at his SpaceX venture in Los Angeles.

Suddenly, I started to take the technology seriously.

Arizona-based Local Motors plans to take a great leap forward with the launch of a 3D printed car next year ([click here](#) for their website).

Dubbed the "Strati" (layers in Italian), the vehicle is made of reinforced carbon fiber thermoplastic, or ABS. It has one fifth the weight of steel with ten times the strength. You can pick up the car with two hands.

The company planned to build two versions of its vehicle during the first quarter of 2016. One would be a low-speed battery car or so-called neighborhood electric vehicle priced between \$18,000 and \$30,000. Faster, higher-priced versions would come later.

While the entry costs to the auto industry are legendarily high, in the billions of dollars, Local Motors' upfront expenses are miniscule by comparison. The 49 foot long printer needed to print the body costs only \$50,000.

Oak Ridge National Labs in Tennessee is a partner in the project which helped develop the monster printer. Nuclear weapons historians will recall them as the first refiner of U-235 during WWII.

It is the first effort to fundamentally change the way cars are put together since Henry Ford modernized the auto assembly line 100 years ago.

Local Motors is an internet creation all the way. It obtained its original funding through crowdsourcing, and held an international contest to find a design. An Italian won, hence the name.

It's hard to see the Strati threatening the Tesla (TSLA), or any conventional car manufacturer any time soon. The current car is not yet street legal, and only does 40 miles per hour.

There is no great trading or investment play here yet. It is still early days. Give it a year or two.

However, it could be a hint of great things to come. I'll take mine in black.

For the YouTube video of and interview with the Strati engineer, [click here](#).



Ah, But is the Girl Printed As Well?

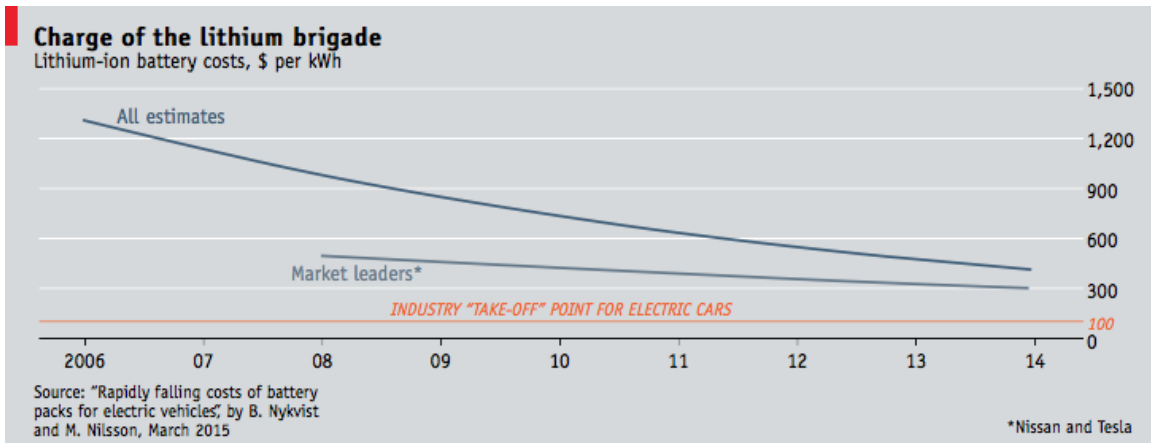
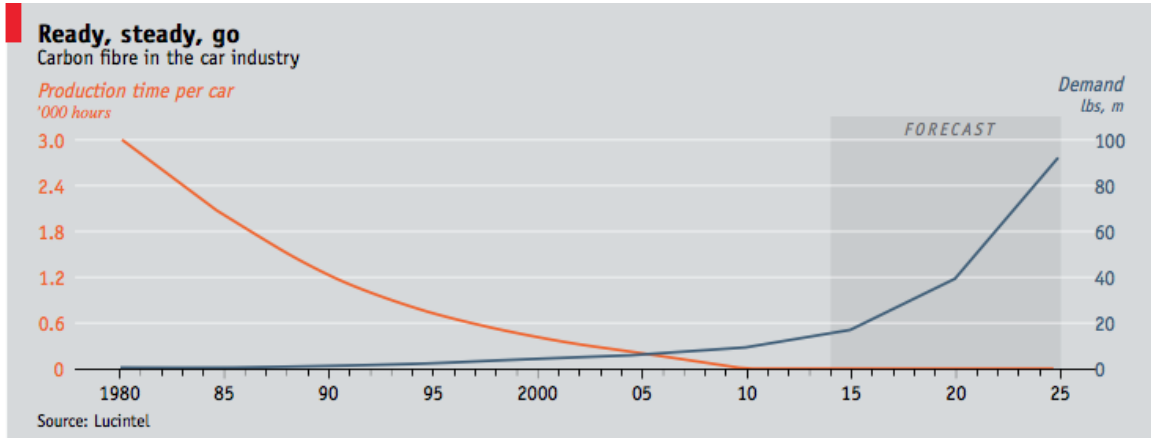

Click [HERE](#) to Learn more about Mad Hedge Fund Trader and the services we offer.

How Tesla Takes Over the World - Part I

I stopped by Tesla's (TSLA) Fremont, California factory in 2016 to test drive my new high performance Model X SUV and noticed something interesting.

There was major new construction underway in the customer delivery area.

That was to be expected, since the company announced that it planned to boost production of its sleek, ultra high-tech Model-S sedan from 51,000 units that year to 93,000. It seemed doable, since there was still a four-month waiting list to obtain a new vehicle.

However, something didn't fit. They weren't doubling the car delivery area. They were increasing it by **10 TIMES!** Clearly, something much larger was afoot.

After chatting up the staff inside, I learned what was really going on. On March 31, 2016, CEO and founder Elon Musk unveiled the next generation all electric Tesla 3 at the Hawthorne, California facility. The move promised to upend the global automobile industry.

The \$35,000 four-passenger car gets a 200-mile range and requires almost no maintenance for its entire life. The batteries offered an eight-year minimum guarantee.

The vehicles can be recharged by plugging in at home, with 90% discounts for charges between 12:00 and 7:00 AM (in California). At that rate, your fuel cost works out to the equivalent of 4 cents per gallon. They can also be juiced up for free in 30 minutes at Tesla's 200-station national supercharger network (see map below).

The cars were fully equipped with self-driving technology, although the system had yet to be fully activated pending regulatory and insurance issues at that time. The first vehicles were to be delivered the following year.

However, Elon had been late with every car he delivered, so 2018 was to be more realistic. Customers don't care. They would rather have delayed perfection than an early, buggy beta model.

Tesla planned to start accepting \$1,000 deposits for the Model 3 online from April 1 that year. The company expected to sell 10,000 on the first day.

The Tesla 3 has always been the final goal of Musk's grand vision to build a carbon-free global economy. The Tesla Roadster and the Model S-1 were really just test beds to develop a mass-market technology.

Tesla planned on producing 500,000 Model 3's within five years. Beyond that, the sky's the limit. The \$6 billion gigafactory, its construction well ahead of schedule (I've flown over it), promises to deliver the lithium ion battery packs to make these lofty goals possible. A second plant was planned.

And here is the stock play in Tesla. The company is not expected to earn real, non-subsidized, accounting gimmick-free earnings for several years. But what is ownership of the global car market in a decade worth today?

Tesla sales this year will only account for 0.55% of total U.S. auto production. But it is easily a decade ahead of any potential competitor in the all electric field, be they American, German, Korean, or Japanese. And it is increasing that lead at an astounding pace.

With the highest quality product, the best electric car brand recognition, the greatest range, and the lowest price point, Tesla should own the global car market by 2025. For decades, their only possible limitation will be the number of cars they can produce, except possibly during recessions.

Add this to the plunging price of solar power, and the cost advantages increase even further. I have been powering my own Tesla S-1 off of my solar panels, and will be adding a second Model X shortly.

It all makes established automakers toast in the 2020s, such as General Motors (GM), Daimler Benz (DDAIF), Toyota (TM), and Nissan Motors (NSANY).

You can forget about chasing the stock up here. The Model 3 launch has already been fully discounted by the meteoric 71.4% gain in the stock at that time.

However, Tesla remains a major holding in long-term value funds such as Ron Baron's Baron Capital, and Fidelity. They see further tenfold gains in the share price from here.

The electric power source is, in fact, the least important aspect of the Tesla cars. Here are 16 reasons that are more important:

- 1) The vehicles have 75% fewer parts than any other, massively reducing production costs. The drive train has 11 parts, compared to more than 1,500 for conventional gasoline powered transportation. Tour the factory and it is eerily silent. There are almost no people, just a handful who service the German robots that put these things together.
- 2) No maintenance is required, as any engineer will tell you about electric motors. You just rotate the tires every 6,000 miles.
- 3) This means that no dealer network is required. There is nothing to fix, no parts to sell.

4) If you do need to repair something, usually it can be done over the phone. Rebooting the computer addresses most issues. If not, they will send a van to do a repair at your house for free.

5) The car runs at room temperature, not the 500 degrees in standard internal combustion cars. This means that the parts last forever.

6) The car is connected to the Internet 24/7. Once a month it upgrades its own software when you are sleeping. You jump in the car the next morning and a message appears on your screen saying, "We just upgraded the following 20 Apps." This is the first car I ever owned that improved itself with age, as I do myself.

7) This is how most of the recalls have been done as well, over the Internet while you are sleeping.

8) If you need to recharge at a public station, it is free. Tesla has its own national network of superchargers that will top you up in minutes, and allow you to drive across the country (see map below). Hotels and businesses have figured out that electric car drivers are the kind of big spending customers they want to attract. Therefore, public stations have been multiplying like rabbits. When I first started driving my Nissan Leaf in 2010 there were only 25 charging stations in the Bay Area. There are now more than 1,000. They even have them at Costco, Walmart, and McDonalds.

9) No engine means a lot more space for other things, like storage. You get two trunks in the Model-S, a generous one behind, and a "frunk" in front.

10) Drive an electric car in California, and you are treated like visiting royalty. You can drive in the HOV commuter lanes as a single driver. This won't last forever, but it's a nice perk now.

11) There is a large and growing market for all American-made products. Tesla has a far higher percentage of U.S. parts (100%) than any of the big three.

12) Since almost every part is made on site at the Fremont factory, supply line disruptions are eliminated. Most American cars are over dependent on Asian supply lines for parts and frequently fall victim to disruptions, such as floods and tidal waves.

13) There are almost no controls, providing for more cost savings. Except for the drivetrain, windows, and turn signals, all vehicle controls are on the touch screen, like a giant iPhone 6 plus.

14) A number of readers have argued that the Tesla really runs on coal, as this is still the source of 36% of the U.S. power supply. However, if you program the car between midnight and 7:00

AM (one of my ideas that Tesla adopted in a recent upgrade), you are using electricity generated by the utilities to maintain grid integrity at night that otherwise goes unused and wasted. How much power is wasted like this in the U.S. every night? Enough to recharge 150 million cars per night!

15) With a waiting list for all new Tesla products, it does not need to advertise. The Detroit Big Three spent \$50 billion on advertising last year. Ouch!

16) Oh yes, the car is good for the environment, a big political issue for at least half the country. When these cars become cheaper than conventional gasoline cars with oil at \$26 a barrel, the entire country will switch over.

See you in Fremont.

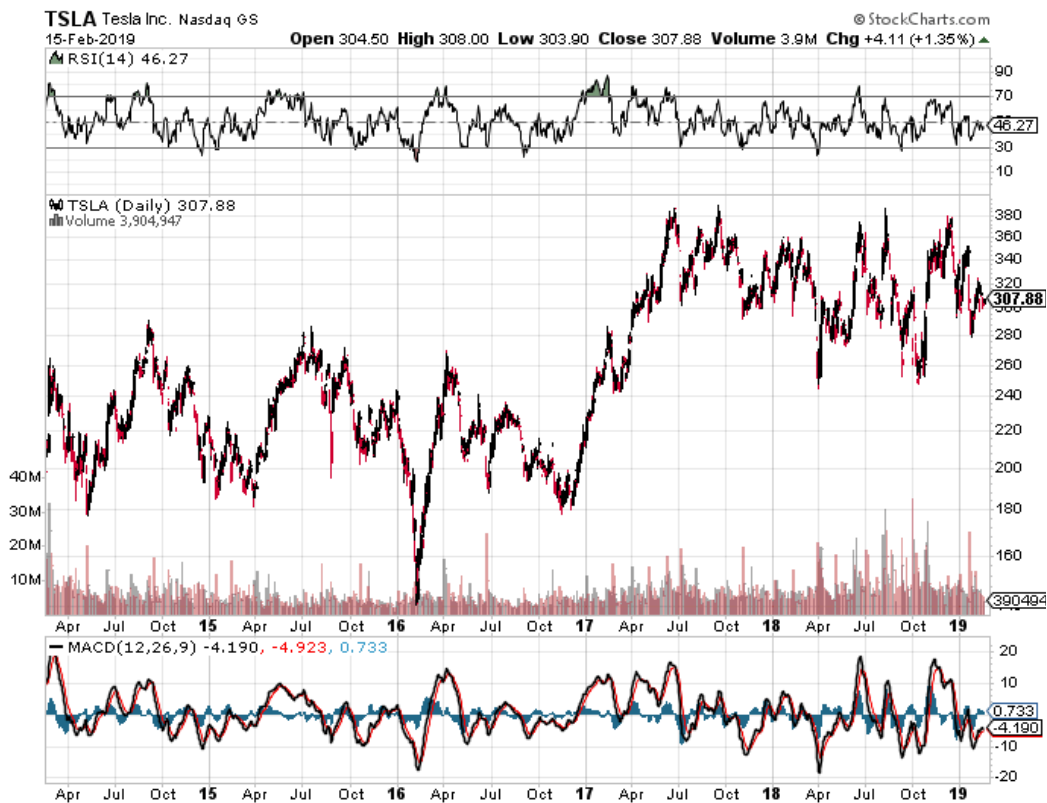





Click [HERE](#) to Learn more about Mad Hedge Fund Trader and the services we offer.

How Tesla Takes Over the World - Part II

I knew I was on the right track when the salesman told me that the customer who just preceded me for a Tesla Model X 90D SUV was the Golden Bay Warriors star basketball player, Steph Curry.

Well, if it's good enough for Steph, then it's good enough for me.

Last week, I received a call from Elon Musk's office to test the company's self-driving technology embedded in their new vehicles for readers of the *Diary of a Mad Hedge Fund Trader*.

I did, and prepare to have your mind blown!

I was driving at 80 MPH on CA-24, a windy eight-lane freeway that snakes its way through the San Francisco East Bay mountains. Suddenly the salesman reached over and flicked a lever on the left side of the driving column.

The car took over!

There it was, winding and turning along every curve, perfectly centered in the lane. As much as I hated to admit it, the car drove better than I ever could.

All that was required was for me to touch the steering wheel every five minutes to prove that I was not sleeping.

The cars do especially well in rush-hour driving, as it is adept at stop-and-go traffic. You can just sit there and work on your laptop, read a book, or watch a movie on the built-in 4G WIFI HD TV.

When we returned to the garage the car really showed off. When we passed a parking space, another button was pushed, and we perfectly backed 90 degrees into a parking space, measuring and calculating all the way.

The range is 255 miles, which I can recharge at home at night from a standard 220-volt socket in seven hours. The chassis can rise as high as 8 inches off the ground so it can function as a true SUV.

The "ludicrous mode," a \$10,000 option, takes you from 0 to 60 mph in three seconds. However, even a standard Tesla can accelerate so fast that it will make the average passenger carsick. Here's the buzzkill.

Tesla absolutely charges through the nose for extras.

The 22-inch wheels are \$5,500, the third row of seats to get you to seven passengers is \$4,000, the premium sound is \$2,500, leather seats are \$2,500, and the self-driving software is \$2,500. A \$750 tow hitch will accommodate a ski rack on the back. There is a \$1,000 delivery charge, even if you pick it up at the Fremont factory.

It's easy to see how you can jump from a \$88,000 base price to a total cost of \$130,000, including taxes.

The middle row of seats **DON'T** fold down flat, limiting your cargo space to 6 feet long and 3 1/2 feet wide. So if you are a frequent hauler of surfboards and skis, as I am, you will have to order the six-seat configuration and squeeze them between the two middle row seats.

My company will be purchasing the car under Section 179 of the International Revenue Code. The car qualifies because it weighs over 6,000 pounds and is therefore a truck under tax law. This allows me to deduct the entire \$130,000 cost of the vehicle up front, plus the maintenance and insurance costs for the entire life of the car. However, I will have to maintain a mileage log as a hedge against any future IRS audits.

Ironically, Section 179 was enacted as a subsidy for consumer purchases of the eight mile per gallon Hummer, which was originally built by AM General and owned by General Motors (GM). After several attempts to sell the division failed, production was permanently shut down. However, the tax subsidies live on for any like-designed vehicle.

What was really amazing was to learn how far the technology has moved forward from my 4-year-old Tesla Model S-1.

The range is now 302 miles. Only four-wheel drive versions are now made. And it too has the self-driving software.

It looks like I'll have to buy two Tesla's this year.

As for "drop-dead" curb appeal, nothing beats the Model X. Concerning the stock, not so much.



Thanks for Your Subscription!

Click [HERE](#) to Learn more about Mad Hedge Fund Trader and the services we offer.

How Tesla Takes Over the World - Part III

Where Driverless Cars Will Take Us

The news that gravitational waves were discovered, as well as wrinkles in the space-time continuum, was big news in my family. Of course, we knew it was coming. It was just a matter of when.

I have 11- and 12-year-old girls (I can't help it if the plumbing still works!). Whenever we drive somewhere, we carry out what Einstein called "thought experiments."

They will come up with scientific questions, and I then direct them into finding their own answers through a series of prodding and hopeful questions. It is much like how the children of royalty were tutored during the Middle Ages.

So they asked, "When will we get driverless cars?" which they had heard about on TV. I answered in about five years, but that I had friends who run Tesla (TSLA) who already have them now. Do you know the interesting thing they discovered? After a year of beta testing, the cars are starting to develop their own personalities.

Each car has highly advanced learning software. When the mapping software requires one to take a difficult sharp left turn, the vehicle may miss it the first time. It will then make the next legal U-turn, and then nail that turn every time in the future.

The cars are all programmed to drive like little old ladies. It will never speed, break the law, and always allows other cars to cut in. Over time, some are becoming cautious, while others are getting more aggressive depending on each individual's driving experience.

In other words, experience is turning them into "people."

I asked, "What would the world be like if everyone had driverless cars?" which will occur in about 30 years, or during their middle age.

They pondered for a moment. Then my older daughter shouted out, "There won't be car accidents any more!" "Right!" I answered.

"But what will that mean?"

They puzzled over this.

A few seconds passed. Then it came. "The people who fix cars won't have anything to do!"

“You got it,” I replied. In fact, about 1 million people in the car repair industry will lose their jobs. A small group of vintage car specialists will survive, much like horse-and-buggy hobbyists do today.

I pointed out that this is already happening because electric cars don’t require any maintenance. You just rotate the tires every 6,000 miles (because electric batteries are so heavy).

I moved on. “Who else will lose their jobs when cars become self driving?” They hit a brick wall. Then I asked “What else breaks when cars have accidents?”

A few seconds later it came. “People!”

“For sure,” I shot back. Actually, about 35,000 people a year die in car accidents in the United States, and another 500,000 are injured.

This means the demand for doctors, hospitals, and ambulances will go down. Say goodbye to another 1 million jobs.

“So, what else will self-driving cars do?” I was relentless.

My older girl was first. “If cars are driven by computers, it means they can drive closer together.” I said, “That was true, but what was the consequence of that?”

The mountain scenery whizzed by. Then they got it.

“There won’t be traffic jams anymore.”

“Yes!” I blurted out. If a car can drive 70 miles per hour, but only needs to remain one car length behind the one in front of it, that effectively increases the capacity of freeways seven times. We will never need to build another freeway again. **Another** 1 million jobs goes down the drain. “What else will self-driving cars do?” I carried on.

They hit a dead-end. So I gave a hint. “What do you see in cities?” After going through buildings, parks, roads, lots of cars, and bridges, I finally got the answer I wanted: “Parking lots.”

I then posed the conundrum, “What’s the connection between self-driving cars and parking lots?”

Now they were getting into the spirit of the thing. “They won’t need them.” I replied “Absolutely.” Self-driving cars won’t need to park. They’ll just be able to drop you off and drive around the block until you are ready to go home. This will be economical because after three decades of battery and solar improvements, energy will effectively be free, like air is today.

Oh, and at least 100,000 parking attendants might as well start joining the unemployment lines now.

It gets better.

Entrepreneurs now are developing apps for cars so they never need to park. In an iteration of the sharing economy, and in a club or membership-type format, your car will just drive person to person, selling rides, until you are ready to go home.

Think of it as **Uber**, without the drivers, that pays **you**.

Today, parking lots occupy about 15% of the land area of large cities. Self-driving cars will free up a lot of that space for other uses, such as housing and parks.

Then I asked the really big question. What do all of these changes have in common?

My 11-year-old picked up on this immediately. "A lot of people are going to lose their jobs!"

"For sure," I bubbled. Notice that **every** new technology improvement creates a lot of job losses. I went on.

"The trick for you girls is to always stay ahead of the technology curve so your job doesn't get lost, too." This is why I have been sending them to Java development school since they were 8 and 9.

They look daunted.

And this is what 11- and 12-year-olds were able to figure out.

Imagine what Google (GOOGL), Apple (AAPL), and Tesla (TSLA) are doing with this idea. It has become a hot button "next big thing." Silicon Valley is now rife with rumors of breakthrough developments and the poaching of staff.

The U.S. military and DARPA are involved in self-driving vehicles in a big way as well, holding regular contests with big prize money and the prospect of mammoth government contracts. More and more generals and admirals are telling me that the wars of the future will be fought with software.

The bottom line is that things are happening much faster than we imagined possible only a few years ago.

Then my oldest daughter piped up.

“Dad, can I get my driver’s license before all the cars are self driving?” I said, “Sure. What kind of car do you want?”

“A red one.”

On our next trip we will cover gravitational waves, Einstein’s Theory of Relativity, and the significance of the clock tower in Bern, Switzerland.

By the way, these girls will be graduating from college in 2026 and 2027 and will be looking for jobs. Just let me know.



Click [HERE](#) to Learn more about Mad Hedge Fund Trader and the services we offer.

The Battery In Your Future

Yesterday, I provided to you the evidence that oil may never again reach a triple digit price [click here](#) for *“Oil: Is it Different This Time?”*

Today I am going to tell you what will replace it.

Sony Corp. (SNE) invented the lithium ion battery in 1991 to power its high-end consumer electronics products. It is now looking like that was a discovery on par with Bell Labs' invention of the transistor in 1947 and Intel's creation of the microprocessor in 1971, although no one knew it at the time.

Until then, battery technology was essentially unchanged since the first one was invented by Alessandro Volta in 1800 and Gaston Plante upgraded it to the lead acid version in 1859. That is the same battery that today starts your conventional gasoline powered car every morning.

The Sony breakthrough proved the springboard for a revolution in battery power. It has fed into cheaper and ever more powerful iPhones, electric cars, and even large-scale utilities.

In 1995, the equivalent of today's iPhone 6 battery cost \$20. Today it can be had for \$1.40 if you buy in bulk, which Apple does by the shipload. That's a cost reduction of a mind-blowing 93%. Electric car batteries have seen prices plunge from \$1,000/kilowatt in 2009 to only \$200 today. Tesla (TSLA) expects that price to drop to \$150 when its \$6 billion new “gigafactory” comes online in Sparks, Nevada, next year. The facility will produce cookie-cutter off-the-shelf batteries made under contract by Japan's Panasonic (Matsushita).

That will pave the way for the Tesla 3 in 2018, a low-end \$35,000 vehicle with a 200-mile range that will take over the global car market.

If you took existing battery technologies and applied them as widely as possible, it would have the effect of reducing American oil consumption from 22 to 18 million barrels a day. That's what the oil market seems to be telling us, with prices at a 13-year low at \$26 a barrel.

Improve battery capabilities just a little bit more and that oil consumption drops by half very quickly.

Both national and state governments are doing everything they can to make that happen. The U.S. is taking the lead here and now has a commanding technology lead over the rest of the world (I can't believe the Germans fell so far behind on this one.).

In 2009, the then President Obama chipped in \$2.4 billion for battery and electric car development as part of his \$787 billion stimulus package. He got a lot of bang for the buck.

So far, I have been the beneficiary of not one, but two \$7,500 federal tax credits for my purchase of my Nissan Leaf and Tesla S-1. The Feds also chipped in another \$13,000 for my new solar roof panels.

A reader once told me that Sweden will ban the sales of gasoline and diesel powered vehicles from 2030. Japan wants electric and hybrids to account for half of its new car sales by 2020.

California has been the most ambitious, investing to obtain 50% of its power from alternative sources by 2030. Some 450,000 homes here already have solar panels, and these are not even counted in the equation.

Solar and wind are already taking over in much of Europe on a non-subsidized, cost-competitive basis.

At the current rate of improvement, electric cars will be cheaper than gasoline powered ones in only a few years. By 2030, a 10-pound battery in your glove compartment (glove box to you in London) will be able to take your car 300 miles. The cost of energy will essentially be free. Then guess what?

Currently, I am able to use my solar panels to charge my 85-kilowatt Tesla battery during the day and then use it to power my home at night. That is enough juice to keep the lights on for three nights. Then, I will be totally off the grid, with utility bills of zero.

Tesla has denied it has such a program, but there is nothing to stop a third party from coming in and providing the service. All it would require is an app and 30 minutes worth of wiring.

To say this will change the geopolitical landscape would be a huge understatement. The one liner here is that oil consumers will benefit enormously, while the producers will get destroyed. I'm talking Armageddon, mass starvation levels of destruction.

In the Middle East, some 1 billion people with the world's highest birth rates will lose their entire source of income.

Russia, which sees half its revenues come from oil, will cease to be a factor on the international stage, and may even undergo a third revolution. Take oil away, and all they have left is hacking. Norwegians will have to start paying for their social services instead of getting them for free. Venezuela, which couldn't make it at \$100 a barrel, will implode, destabilizing Latin America. It's going to be an interesting decade for us geopolitical commentators.

Further improvements in battery power per dollar will change the U.S. economy beyond all recognition. This will be a big win for the 90% of the economy that consumes energy and an existential crisis for the 10% that produce it.

Public utilities will have to change their business models from power producers to distributors. No less an authority than former Energy Secretary Dr. Steven Chu (another Berkeley grad) has warned the industry that they must change or get “Fedexed,” much the same way that overnight delivery replaced the U.S. Postal Service.

U.S. oil majors will suffer some very tough times, but won’t disappear. My bet has always been that they will buy the entire alternatives industry the second it becomes profitable.

After all, they are not in the oil business, but rather in the profit-making business, and they certainly have the cash, and the management and engineering expertise to pull this off. Exxon (XOM) will turn green out of necessity.

As is always the case, there are very few publicly listed stock plays in a brand new emerging technology such as the battery sector. Many of the early stage entrants have already filed for bankruptcy and had their assets taken over for pennies.

It’s a business you want to be in because Citibank expects that giant grid scale batteries alone will be a \$400 billion a year market by 2030.

When I visit friends at the oil majors in Houston, I chide them to be kind to that Birkenstock wearing long-haired visitor.

He may be their future boss.

Click [HERE](#) to Learn more about Mad Hedge Fund Trader and the services we offer.

The American Onshoring Trend is Accelerating

Have you tried to hire a sewing machine operator lately?

I haven't, but I have friends running major apparel companies who have (guess where I get all those tight-fitting jeans?).

Guess what? There aren't any to be had.

Since 1990, some 77% of the American textiles workforce has been lost when China joined the world economy in force, and the offshoring trend took flight.

Now that manufacturing is at last coming home, the race is on to find the workers to man it. Welcome to onshoring 2.0.

The development has been prompted by several seemingly unrelated events. There is an ongoing backlash to several disasters at garment makers in Bangladesh, the current low-cost producer, which have killed thousands.

Today's young consumers want to look cool, but have a clean conscience as well. That doesn't happen when your threads are sewn together by child slave laborers working for \$1 a day.

Several firms are now tapping into the high-end market where the well-off are willingly paying top dollar for a well-made "Made in America" label.

Look no further than **7 For All Mankind** which is offering just such a product at a discount to all recent buyers of the Tesla Model S-1 (TSLA), that other great all-American manufacturer ([click here](#) for the website).

As a result, wages for cut-and-sew jobs are now among the fastest growing in the country, up 13.2% in real terms since 2007, versus a paltry 1.4% for industry as a whole.

Apparel industry recruiters are plastering high schools and church communities with flyers in their desperate quest for new workers. They advertise in languages with high proportions of blue-collar workers, such as Spanish, Somali, and Hmong.

New immigrants are particularly being targeted. And yes, they are resorting to the technology that originally hollowed out their industry, creating websites to suck in new applicants.

Chinese workers now earn \$3 an hour versus \$9 plus benefits at the lowest-paying U.S. factories. But the extra cost is more than made up for by savings in transportation and logistics, and the rapid time to market.

That is a crucial advantage in today's fast-paced, high-turnover fashion world. Some companies are even returning to the hiring practices of the past, offering free training programs and paid internships.

By now, we have all become experts in offshoring, the practice whereby American companies relocate manufacturing jobs overseas to take advantage of low wages, missing unions, the lack of regulation, and the paucity of environmental controls.

The strategy has been by far the largest source of new profits enjoyed by big companies for the past two decades. It has also been blamed for losses of U.S. jobs, with some estimates reaching as high as 25 million.

When offshoring first started 50 years ago, it was a total no-brainer. Wages were sometimes 95% cheaper than those at home. The cost savings were so great that you could amortize your total capital costs in as little as two years.

So, American electronics makers began flying overseas to Singapore, Thailand, Hong Kong, Taiwan, South Korea, and the Philippines. After the U.S. normalized relations with China in 1978, the action moved there and found that labor was even cheaper.

Then, a funny thing happened. After 30 years of falling real American wages and soaring Chinese wages, offshoring isn't such a great deal anymore. The average Chinese laborer earned \$100 a year in 1977.

Today, it is \$6,000 and \$24,000 for trained technicians, with total compensation rising 20% a year. At this rate, U.S. and Chinese wages will reach parity in about 10 years.

However, wages won't have to reach parity for onshoring to accelerate in a meaningful way. Investing in China is still not without risks. Managing a global supply chain is no piece of cake on a good day. Asian countries still lack much of the infrastructure that we take for granted here.

Natural disasters such as earthquakes, fires and tidal waves can have a hugely disruptive impact on a manufacturing system that is in effect a finely tuned, incredibly complex watch.

There are also far larger political risks keeping a chunk of our manufacturing base in the Middle Kingdom than most Americans realize. With the U.S. fleet and the Chinese military playing an endless game of chicken off the coast, we are one mid air collision away from a major diplomatic incident.

Protectionism constantly threatens to boil over in the U.S., whether it is over the dumping of chicken feet, tires, or the latest, solar cells.

This is what the visit to the Foxconn factory by Apple's CEO Tim Cook, was all about. Be nice to the workers there, let them work only 8 hours a day instead of 16, let them unionize, and guess what?

Work will come back to the U.S. all the faster. The Chinese press was ripe with speculation that Apple-induced reforms might spread to the rest of the country like wildfire.

Former General Motors (GM) CEO Dan Akerson, told me his company was reconsidering its global production strategy in the wake of the Thai floods. Which car company was most impacted by the Japanese tsunami? General Motors, which obtained a large portion of its transmissions there.

The impact of a real onshoring move on the U.S. economy would be huge. Some economists estimate that as many as 10% to 30% of the jobs lost to offshoring could return. At the high end, this could amount to 8 million jobs. That would cut our unemployment rate down by half, at least.

It would add \$20 billion to \$60 billion in GDP per year, or up to 0.4% in economic growth per year. It would also lead to a much stronger dollar, rising stocks, and lower bond prices. Is this what the stock market is trying to tell us by failing to have any meaningful correction for the past 2 ½ years?

Who would be the biggest beneficiaries of an onshoring trend? Si! Ole! Mexico (UMX) (EWW), which took the biggest hit when China started soaking up all the low-waged jobs in the world. After that, the industrial Midwest has to figure pretty large, especially gutted Michigan. With real estate prices there under their 1992 lows, if there is a market at all, you know that doing business there costs a fraction of what it did 20 years ago.



So How Does This Thing Work?

Click [HERE](#) to Learn more about Mad Hedge Fund Trader and the services we offer.

Do You Want to Live Forever?

When I was a DNA scientist at UCLA 45 years ago, the team used to slack off whenever our professor was attending an out-of-town conference.

We used to take pure 200-proof ethanol the university kept on hand “for research purposes”, used it to bring our beer up to 100 proof, and then speculate about the future of our obscure, neglected field.

With the technology at hand, we predicted it would take 3,000 years to fully decode the 3 billion base pairs of a length of human DNA. It then might take another 1,000 years to manipulate our genes to accomplish something useful, like curing cancer.

Maybe it was our “enhanced” beer talking, but we were off on our bold forecast by only 2,970 years.

Dr. Craig Venter published a map of his own DNA in 2001 using sophisticated algorithms to vastly accelerate our own snail-like progress.

The second step, that of functional genetic engineering, took only another decade instead of a millennium.

Clustered Regularly Interspaced Short Palindromic Repeats (CRISPR).

Memorize this term, write it in your diary, and put it on a sticky note on your computer. It may save your life someday, if not add decades to it.

And it could also make you a multimillionaire, if you play your cards right. More on that below. I count myself on becoming one of its fortunate users, once the technology goes retail, which should be soon.

If you are another DNA scientist, all I need to tell you is that **CRISPR** is used to manipulate segments of [prokaryotic DNA](#) containing short repetitions of base sequences.

Each repetition is followed by short segments of [spacer DNA](#) from previous exposures to a bacteriophage virus or [plasmids](#). The protein fragments that identify and snip these crucial gene segments are called **CRISPRs**.

If you are more interested in trading than genetics, which most of my subscribers are, suffice it to say that **CRISPR** is a technology being developed that will enable you to edit your own DNA on a customized basis and then pass the changes onto your progeny.

This will eventually allow you to become immune to all diseases, increase your intelligence, and possibly live forever. Just cut out a bad gene, put in a new one and you, and all your future descendants are fixed for good.

You only have to make it five or 10 more years at the most with your current vintage DNA, and you can easily live another century.

Oh, and by the way, the company that successfully brings **CRISPR** products to market in an economical, cost-effective way should see its stock price rise tenfold, if not a hundredfold. Interested?

Reading up on the research for this piece, one thought kept recurring in my mind: "I can't believe they are already doing this **NOW!**"

CRISPR technology was first noted by a Japanese researcher in 1987. It turns out that the Japanese have a huge head start in developing DNA technologies thanks to a 300-year track record in brewing potent rice wines, such as **sake**.

By 2007, **CRISPR** went mainstream, attracting funding from a broad range of industries. There was initial heavy interest from the food producers which sought to make plants and their seeds immune to common crop destroying diseases.

Their work is partly responsible for the record crop yields that are presently crushing agricultural prices across the board.

As of today, there have been more than 1,000 peer-reviewed papers published about **CRISPR**, each one taking us an infinitesimal step forward.

Currently, there are clinical trials underway employing **CRISPR** technology to fight multiple forms of cancer, herpes viruses, and advance immunosuppression in human organ transplants.

A legal battle has already broken out over who owns the rights to CRISPR technology, with Thermo Fisher Scientific (TMO) holdings several key patents. The shares have gained an impressive 35% recently.

OvaScience Inc. (OVAS) has started applying CRISPR to human embryos. It didn't take long to ignite a firestorm of controversy over the prospect of permanently altering the human germline.

Will the wealthy buy their way into genetic superiority and immortality? Or will we accidentally create an organism that could wipe out the human race? Cries of “Social Darwinism” abound. Or worse, what if the Chinese make their own population immune to a bioweapon that they then unleash on the rest of the world?

What if a gene treatment that cures cancer also makes individuals aggressive, paranoid, or violent?

Talk about letting a genie out of a bottle while also opening Pandora’s box!

Some leading scientific journals, such as **Nature** and **Science**, have refused to publish some **CRISPR** papers over ethical concerns. Unsurprisingly, Chinese scientists have the lead in the most controversial applications.

It’s all way above my pay grade.

During my lifetime I have seen science drop some real clangers.

While in Europe this summer, I saw a thalidomide baby grown up, now in his 50s. The anti-morning sickness drug developed by a German company produced children with flippers instead of arms.

Even today, thalidomide is held out as an example of the need for enhanced drug regulation in the U.S.

In the early 1950s, one doctor developed the bright idea of giving newborn babies pure oxygen. Everyone eventually went completely blind for life.

And then the CIA developed LSD as a potential weapon, testing it on it's own unwitting employees, who developed an unfortunate tendency to jump out of windows from high floors. We all know how that one worked out.

We already know what genes people will choose when given the opportunity to do so, instead of using the ones they inherited the old-fashioned way.

The unregulated human artificial insemination industry makes available genotypes of every race and nationality in abundance. More than 90% choose tall, blonde, intelligent donors, inadvertently creating a financial windfall from the UC Berkeley Men’s Water Polo Team. It is an outcome of which Adolf Hitler would have been proud, as more than 1 million of these children have been born in the U.S. alone.

Some prolific water polo players have sired more than 100 children, which are now using websites such as **23andMe** and **Ancestry.com** to find each other and socialize.

It was not in the game plan.

As is always the case with new, cutting-edge, groundbreaking technologies, it is hard to find a rifle shot investment that gives you a pure play.

Many such efforts are subsumed inside huge companies where a specific technology never moves the needle. Startups often go bust because they can't keep up with rapidly evolving technology.

That's what happened to the 3D printing industry, and I can't remember how many hard drive companies and PC makers have gone under.

Editas, Caribou Biosciences, Intellia, CRISPR Therapeutics, and Precision Biosciences are all privately owned by the founders and the venture capital firms that funded them. Still, you might get a bite of the apple when these firms go public in a few years.

Cellectis (CLLS) is a \$1.1 billion French company that is involved in both gene editing and [cancer immunotherapy](#). The company has improved the quality of crops for the food and agriculture industries.

Sangamo Biosciences (SGMO) is a \$1 billion California-based company that has entered Phase 1 clinical trials for a gene-editing technique that is showing encouraging results as [a possible functional cure for HIV](#).

Many will find the prospect of living another century enticing. I might be interested if I could get back the body I had when I was 25.

The possibility of finding a stock that could rise 10 or 100 times is **MUCH** more interesting.

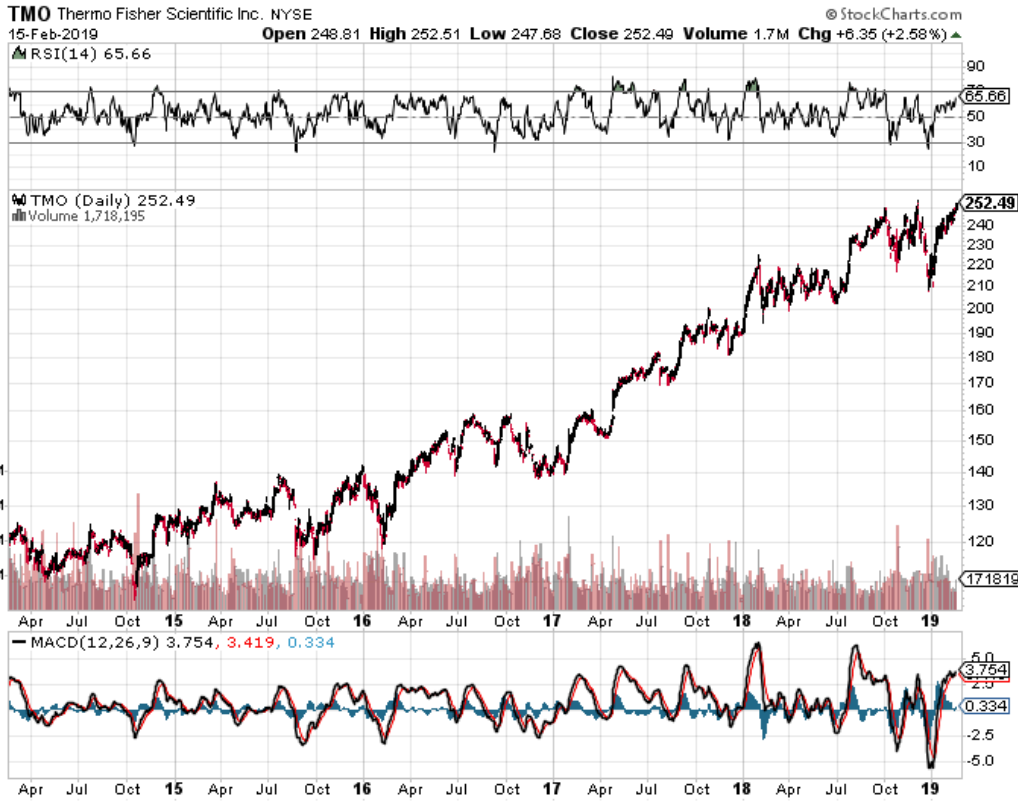



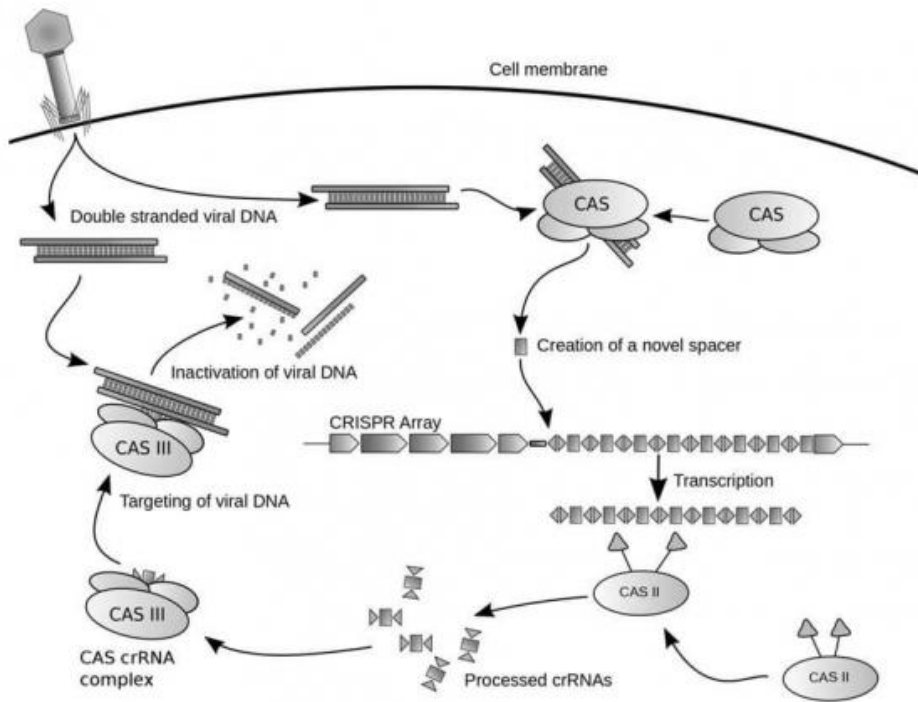

CRISPR Cas-9 and Genome Editing

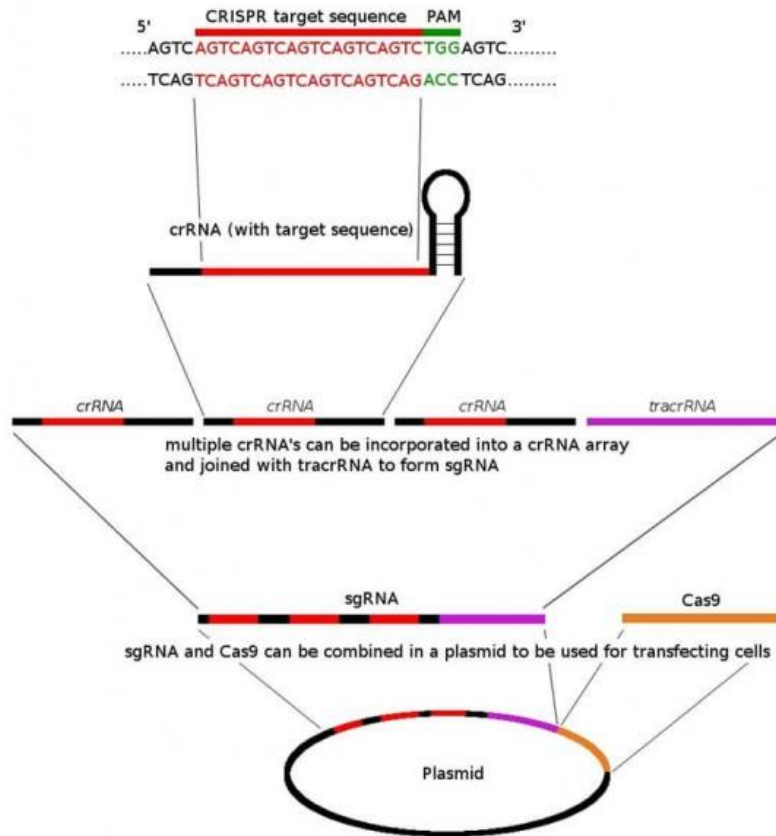



Click [HERE](#) to Learn more about Mad Hedge Fund Trader and the services we offer.

Peeking into the Future with Ray Kurzweil

This is the most important research piece you will ever read, bar none. You'll have to finish it to understand why. So, I will get on with the show.

I have been hammering away at my followers at investment conferences, webinars, and strategy luncheons this year about one recurring theme. Things are good, and about to get better, a whole lot better.

The driver will be the exploding rate of technological innovation in electronics, biotechnology, and energy. The 2020s are shaping up to be another roaring twenties, and asset prices are going to go through the roof.

To flesh out some hard numbers about growth rates that are realistically possible and which industries will be the leaders, I hooked up with my old friend, Ray Kurzweil, one of the most brilliant minds in computer science.

Kurzweil is currently a director of Engineering at Google (GOOG), heading up a team that is developing stronger artificial intelligence. He is an MIT grad, with a double major in computer science and creative writing. He was the principal inventor of the CCD flatbed scanner, first text-to-speech synthesizer, and the commercially marketed large-vocabulary speech recognition.

When he was still a teenager, Kurzweil was personally awarded a science prize by President Lyndon Johnson. He has received 20 honorary doctorates and has authored seven books. It was upon Ray's shoulders that many of today's technological miracles were built.

His most recent book, ***The Singularity Is Near: When Humans Transcend Biology***, was a ***New York Times*** best seller. In it he makes hundreds of predictions about the next 100 years that will make you fall out of your chair.

I met Kurzweil at one of my favorite San Francisco restaurants, Morton's on Post Street. I ordered a dozen oysters; a filet mignon wrapped in bacon, and drowned it all down with a fine bottle of Duckhorn merlot. Ray had a wedge salad without dressing, a giant handful of nutritional supplements, and a bottle of water. That's Kurzweil, one cheap date.

The Future of Man

A singularity is defined as a single event that has monumental consequences. Astrophysicists refer to the big bang and black holes in this way. Kurzweil's singularity has humans and machines merging to become single entities, partially by 2040 and completely by 2100.

All of our thought processes will include built-in links to the cloud, making humans super smart. Skin that absorbs energy from the sun will eliminate the need to eat. Nanobots will replace blood cells, which are far more efficient at moving oxygen. A revolution in biotechnology will enable us to eliminate all medical causes of death.

Most organs can now be partially or completely replaced. Eventually they all will become renewable by taking one of your existing cells and cloning it into a completely new organ. We will become much more like machines, and machines will become more like us.

The first industrial revolution extended the reach of our bodies, and the second is extending the reach of our minds.

And, oh yes, prostitution will be legalized and move completely online. Sound like a turn off? How about virtually doing it with you favorite movie star? Your favorite investment advisor? Yikes!

Ironically, one of the great accelerants toward this singularity has been the war in Iraq. More than 50,000 young men and women came home missing arms and legs (in Vietnam these were all fatalities, thanks to the absence of modern carbon fiber body armor).

Generous government research budgets have delivered huge advances in titanium artificial limbs and the ability to control them only with thoughts. Quadriplegics can now hit computer keystrokes merely by thinking about them.

Kurzweil argues that exponentially growing information technology is encompassing more and more things that we care about, such as healthcare and medicine. Reprogramming of biology will be the next big thing, and is a crucial part of his “singularity.”

Our bodies are governed by obsolete genetic programs that evolved in a bygone era. For example, over millions of years our bodies developed genes to store fat cells to protect against a poor hunting season in the following year. That gave us a great evolutionary advantage 10,000 years ago. But it is not so great now, with obesity becoming the country’s No. 1 health problem.

We would love to turn off these genes through reprogramming, confident that the hunting at the supermarket next year will be good. We can do this in mice now, which in experiments can eat like crazy, but never gain weight.

The happy rodents enjoy the full benefits of caloric restriction, with no hint of diabetes or heart disease. A product like this would be revolutionary, not just for us, health care providers, and the government, but, ironically, for fast food restaurants as well.

Within the past five years, we have learned how to reprogram stem cells to rebuild the hearts of heart attack victims. The stem cells are harvested from skin cells, not human embryos, ducking the political and religious issue of the past.

And if we can turn off genes, why not the ones in cancer cells that enable them to pursue unlimited reproduction, until they kill its host? That development would cure all cancers, and is probably only a decade off.

The Future of Computing

If this all sounds like science fiction, you'd be right. However, Kurzweil points out that humans have chronically underestimated the rate of technological innovation.

This is because humans evolved to become linear thinking animals. If a million years ago we saw a gazelle running from left to right, our brains calculated that one second later it would progress 10 feet further to the right. That's where we threw the spear. This gave us a huge advantage over other animals, and is why we became the dominant species.

However, much of science, technology, and innovation grows at an exponential rate, and is where we make our most egregious forecasting errors. Count to seven, and you get to seven. However, double something seven times and you get to a billion.

The history of the progress of communications is a good example of an exponential effect. Spoken language took hundreds of thousands of year to develop. Written language emerged thousands of years, books in a 100 years, the telegraph in a century, and telephones 50 years later.

Some 10 years after Steve Jobs brought out his Apple II personal computer, the growth of the Internet went hyperbolic. Within three years of the iPhone launch, social media exploded out of nowhere.

At the beginning of the 20th century, \$1,000 bought 10 X -5th power worth of calculations per second in our primitive adding machines. A hundred years later a grand got you 10 X 8th power calculations, a 10 trillion-fold improvement. The present century will see gains many times this.

The iPhone itself is several thousand times smaller, a million times cheaper, and billions times more powerful than computers of 40 years ago. That increases price per performance by the trillions. More dramatic improvements will accelerate from here.

Moore's law is another example of how fast this process works. Intel (INTC) founder Gordon Moore published a paper in 1965 predicting a doubling of the number of transistors on a printed circuit board every two years. Since electrons had shorter distances to travel, speeds would double as well.

Moore thought that theoretical limits imposed by the laws of physics would bring this doubling trend to end by 2018, when the gates become too small for the electrons to pass through. For decades I have read research reports predicting that this immutable deadline would bring an end to innovation and technological growth, and bring an economic Armageddon.

Kurzweil argues that nothing could be further from the truth. A paradigm shift will simply allow us to leapfrog conventional silicon based semiconductor technologies and move on to bigger and better things. We did this when we jumped from vacuum tubes to transistors in 1949, and again in 1959, when Texas Instruments (TXN) invented the first integrated circuit.

Paradigm shifts occurred every 10 years in the past century, every five years in the past decade, and will occur every couple of years in the 2020s. So fasten your seatbelts!

Nanotechnology has already allowed manufacturers to extend the 2018 Moore's law limit to 2022. On the drawing board are much more advanced computing technologies, including calcium-based systems, using the alternating direction of spinning electrons, and nanotubes.

Perhaps the most promising is DNA-based computing, a high research priority at IBM and several other major firms. I earned my own 15 minutes of fame in the scientific world 40 years ago as a member of the first team ever to sequence a piece of DNA, which is why Kurzweil knows who I am.

Deoxyribonucleic acid makes up the genes that contain the programming that makes us who we are. It is a fantastically efficient means of storing and transmitting information and it is found in every single cell in our bodies. All 10 trillion of them.

The great thing about DNA is that it replicates itself. Just throw it some sugar. That eliminates the cost of building the giant \$2 billion silicon-based chip fabrication plants of today.

The entire human genome is a sequential binary code containing only 800 MB of information, which after you eliminate redundancies, has a mere 30-100 MB of useful information. That is about the size of an off-the-shelf software program, like Word for Windows. Unwind a single DNA molecule, and it is only 6 feet long.

What this means is that, just when many believe that our computer power is peaking, it is in fact just launching on an era of exponential growth. Super computers surpassed human brain computational ability in 2012, about 10 to the 16th power (10 quadrillion) calculations per second.

That power will be available on a low-end laptop by 2020. By 2050, this prospective single laptop will have the same computing power of the entire human race, about 9 billion individuals. It will also be small enough to implant in our brains.

The Future of the Economy

Kurzweil is not really that interested in financial markets, or for that matter, making money. Where technology will be in a half century and how to get us there are what get his juices flowing. However, I did manage to tease a few mind-boggling thoughts from him.

At the current rate of change, the 21st century will see 200 times the technological progress that we saw in the 20th century. Shouldn't corporate profits, and therefore share prices, rise by as much?

Technology is rapidly increasing its share of the economy, and increasing its influence on other sectors. That's why tech has been everyone's favorite sector for the past 30 years, and will remain so for the foreseeable future. For two centuries, technology has been eliminating jobs at the bottom of the economy, and creating new ones at the top.

Stock analysts and investors make a fatal flaw estimating future earnings based on the linear trends of the past, instead of the exceptional growth that will occur in the future.

In the past century, the Dow appreciated from 100 to 10,000, an increase of 100 times. If we grow at that rate in this century, the Dow should increase by 10,000% to 1 million by 2100. But so far, we are up only 6%, even though we are already 14 years into the new century.

The index is seriously lagging, but will play catch up in a major way during the 2020s, when economic growth jumps from 2% to 4% or more, thanks to the effects of massively accelerating technological change.

Some 100 years ago, one-third of jobs were in farming, one-third were in manufacturing, and one-third in services. If you predicted then that in a century farming and manufacturing would each be 3% of total employment and that something else unknown would come along for the rest of us, people would have been horrified. However, that's exactly what happened.

Solar energy use is also on an exponential path. It is now 1% of the world's supply, but is only seven doublings away from becoming 100%. Then we will consume only one 10,000th of the sunlight hitting the earth. Geothermal energy offers the same opportunities.

We are only running out of energy if you limit yourself to 19th century methods. Energy costs will plummet. Eventually, energy will be essentially free when compared to today's costs, further boosting corporate profits.

Hyper growth in technology means that we will be battling with deflation for the rest of the century, as the cost of production and price of everything falls off a cliff. That makes our 10-year Treasury bonds a steal at a generous 2.60% yield, a full 460 basis points over the real long-term inflation rate of negative 2% a year.

U.S. Treasuries could eventually trade down to the 0.40% yields seen in Japan only a couple of years ago. This means that the bull market in bonds is still in its early stages, and could continue for decades.

The upshot for all of this, these technologies will rapidly eliminate poverty, not just in the U.S., but around the world. Each industry will need to continuously reinvent its business model, or disappear.

The takeaway for investors is that stocks, as well as other asset prices, are now wildly undervalued given their spectacular future earnings potential. It also makes the Dow target of 1 million by 2100 absurdly low, and off by a factor of 10 or even 100. Will we be donning our "Dow 100 Million" then?

Other Random Thoughts

As we ordered dessert, Kurzweil launched into another stream of random thoughts. I asked for Morton's exquisite double chocolate mousse. Ray had another handful of supplements. Yep, Mr. Cheap Date.

The number of college students has grown from 50,000 to 12 million since the 1870s. A kid in Africa with a cell phone has more access to accurate information than the president of the United States did 15 years ago.

The great superpower, the Soviet Union, was wiped out by a few fax machines distributing information in 1991.

Company offices will become entirely virtual by 2025.

Cows are very inefficient at producing meat. In the near future, cloned muscle tissue will be produced in factories, disease free, and at a fraction of the present cost, without the participation of the animal. PETA will be thrilled.

Use of nanomaterials to build ultra-light but ultra-strong cars cuts fuel consumption dramatically. Battery efficiencies will improve by 10 to 100 times. Imagine powering the Tesla Model S1 with a 10-pound battery! Advances in nanotube construction mean the weight of the vehicle will drop from the present 3 tons to just 100 pounds, but will be far safer.

Kurzweil is also on a scientific advisory panel for the U.S. Army. Uncertain about my own security clearance, he was reluctant to go into detail. Suffice it to say that the weight of an M1 Abrams main battle tank will shrink from 70 tons to 1 ton, but will be 100 times stronger.

A zero-tolerance policy toward biotechnology by the environmental movement exposes their intellectual and moral bankruptcy. Opposing a technology with so many positive benefits for

humankind and the environment will inevitably alienate them from the media and the public, who will see the insanity of their position.

Artificial intelligence is already far more prevalent than you understand. The advent of strong artificial intelligence will be the most significant development of this century. You can't buy a book from Amazon, withdraw money from your bank, or book a flight, without relying on A.I. Kurzweil finished up by saying that by 2100, humans will have the choice of living in a biological, or in a totally virtual, online form. In the end we will all just be files.

Personally, I prefer the former, as the best things in life are biological, and free!

I walked over to the valet parking, stunned and disoriented by the mother load of insight I had just obtained, and it wasn't just the merlot talking, either! Imagine what they talk about at Google all day.

To buy ***The Singularity Is Near*** at discount Amazon pricing, please [click here](#). It is worth purchasing the book just to read Kurzweil's single chapter on the future of the economy.

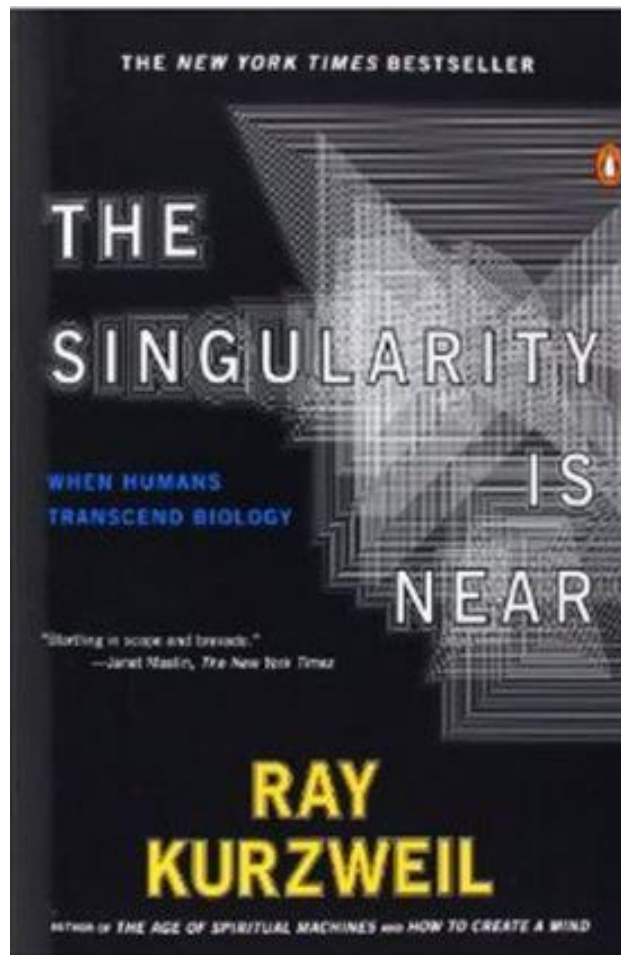



Did You Say “BUY” or “SELL?”



The Future is Closer than You Think

Click [HERE](#) to Learn more about Mad Hedge Fund Trader and the services we offer.